

SONY®

Sound Bar

Operating Instructions

WARNING

To reduce the risk of fire, do not cover the ventilation opening of the appliance with newspapers, tablecloths, curtains, etc.

Do not expose the appliance to naked flame sources (for example, lighted candles).

To reduce the risk of fire or electric shock, do not expose this appliance to dripping or splashing, and do not place objects filled with liquids, such as vases, on the appliance.

Do not install the appliance in a confined space, such as a bookcase or built-in cabinet.

Do not expose batteries or appliances with battery-installed to excessive heat, such as sunshine and fire.

To prevent injury, this apparatus must be securely placed on the cabinet or attached to the floor/wall in accordance with the installation instructions.

Indoor use only.

On power sources

- The unit is not disconnected from the mains as long as it is connected to the AC outlet, even if the unit itself has been turned off.
- As the main plug is used to disconnect the unit from the mains, connect the unit to an easily accessible AC outlet. Should you notice an abnormality in the unit, disconnect the main plug from the AC outlet immediately.

Recommended cables

Properly shielded and grounded cables and connectors must be used for connection to host computers and/or peripherals.

For product with CE marking

The validity of the CE marking is restricted to only those countries where it is legally enforced, mainly in the countries EEA (European Economic Area).

For customers in Europe



Disposal of waste batteries and electrical and electronic equipment (applicable in the European Union and other European countries with separate collection systems)

This symbol on the product, the battery or on the packaging indicates that the product and the battery shall not be treated as household waste. On certain batteries this symbol might be used in combination with a chemical symbol.

The chemical symbols for mercury (Hg) or lead (Pb) are added if the battery contains more than 0.0005% mercury or 0.004% lead. By ensuring these products and batteries are disposed of correctly, you will help prevent potentially negative consequences for the environment and human health which could otherwise be caused by inappropriate waste handling. The recycling of the materials will help to conserve natural resources.

In case of products that for safety, performance or data integrity reasons require a permanent connection with an incorporated battery, this battery should be replaced by qualified service staff only. To ensure that the battery and the electrical and electronic equipment will be treated properly, hand over these products at end-of-life to the applicable collection point for the recycling of electrical and electronic equipment. For all other batteries, please view the section on how to remove the battery from the product

safely. Hand the battery over to the applicable collection point for the recycling of waste batteries. For more detailed information about recycling of this product or battery, please contact your local Civic Office, your household waste disposal service or the shop where you purchased the product or battery.

Notice for customers: the following information is only applicable to equipment sold in countries applying EU directives.

This product has been manufactured by or on behalf of Sony Corporation, 1-7-1 Konan Minato-ku Tokyo, 108-0075 Japan. Inquiries related to product compliance based on European Union legislation shall be addressed to the authorized representative, Sony Belgium, bijkantoor van Sony Europe Limited, Da Vincilaan 7-D1, 1935 Zaventem, Belgium. For any service or guarantee matters, please refer to the addresses provided in the separate service or guarantee documents.

Hereby, Sony Corp., declares that this equipment is in compliance with the essential requirements and other relevant provisions of Directive 1999/5/EC.

For details, please access the following URL: <http://www.compliance.sony.de/>



This Sound Bar is intended for sound playback from connected devices and music streaming from a BLUETOOTH device.

This equipment has been tested and found to comply with the limits set out in the EMC regulation using a connection cable shorter than 3 meters.

For customers in Australia and India



Disposal of Old Electrical & Electronic Equipment (Applicable in the European Union and other European countries with separate collection systems)

Copyrights and Trademarks

- This system incorporates Dolby* Digital.
 - * Manufactured under license from Dolby Laboratories. Dolby, Dolby Audio, and the double-D symbol are trademarks of Dolby Laboratories.
- The BLUETOOTH® word mark and logos are registered trademarks owned by Bluetooth SIG, Inc. and any use of such marks by Sony Corporation is under license. Other trademarks and trade names are those of their respective owners.
- This system incorporates High-Definition Multimedia Interface (HDMI™) technology. The terms HDMI and HDMI High-Definition Multimedia Interface, and the HDMI Logo are trademarks or registered trademarks of HDMI Licensing, LLC in the United States and other countries.
- "BRAVIA" is a trademark of Sony Corporation.
- "PlayStation" is a registered trademark of Sony Computer Entertainment Inc.
- MPEG Layer-3 audio coding technology and patents licensed from Fraunhofer IIS and Thomson.
- Windows Media is either a registered trademark or trademark of Microsoft Corporation in the United States and/or other countries.

- This product is protected by certain intellectual property rights of Microsoft Corporation. Use or distribution of such technology outside of this product is prohibited without a license from Microsoft or an authorized Microsoft subsidiary.
- "ClearAudio+" is a trademark of Sony Corporation.
- Other system and product names are generally trademarks or registered trademarks of the manufacturers. ™ and ® marks are not indicated in this document.

About these operating instructions

- The instructions in these Operating Instructions describe the controls on the remote control. You can also use the controls on the Bar Speaker if they have the same or similar names as those on the remote control.
- Some illustrations are presented as conceptual drawings, and may be different from the actual products.

Table of Contents

About these operating instructions	4
Guide to parts and controls	6

Installing the system

Basic connections and preparation	Startup Guide (separate document)
-----------------------------------	-----------------------------------

Mounting the Bar Speaker on a wall	10
Installing the subwoofer horizontally	12

Listening to the sound

Listening to sound from the connected devices	12
Listening to music from a USB device	12

Sound Adjustment

Enjoying sound effects	14
Adjusting the subwoofer volume	16

BLUETOOTH Functions

Listening to music from a BLUETOOTH device	16
Setting the BLUETOOTH standby mode	17

Other Functions

Using the Control for HDMI function	18
Using the "BRAVIA" Sync function	19
Auto standby function	20
Activating wireless transmission between specific units (Secure Link)	20

Additional Information

Precautions	21
Troubleshooting	22
Playable types of files	27
Supported audio formats	27
LED indicators	28
Specifications	30
On BLUETOOTH communication	31

Guide to parts and controls

For more information, refer to the pages indicated in parentheses.

Bar Speaker

Top and front panel

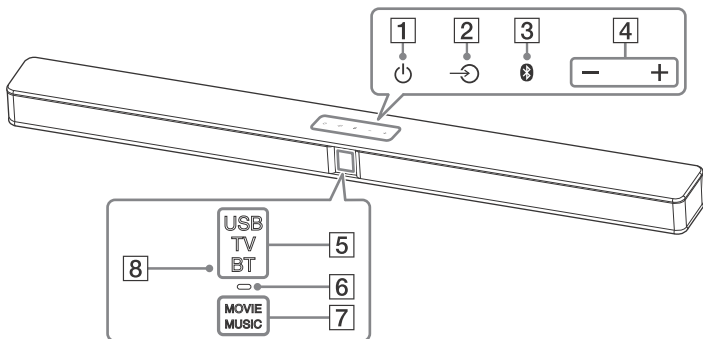

- 1** **(power) touch key**
Turns on the system or sets it to standby mode.
- 2** **(input) touch key (page 12)**
Selects the device you want to use.
- 3** **(pairing) touch key (page 16)**
- 4** **+/- (volume) touch key**
- 5** **Input indicators* (page 12)**
- 6** **BLUETOOTH indicator (blue)**
 - Flashes quickly: During BLUETOOTH pairing
 - Flashes: BLUETOOTH connection is being attempted
 - Lights up: BLUETOOTH connection is established

- 7** **Sound effect indicators* (page 14)**

- 8** **Remote control sensor**

* LED indicators which light up or flash depending on the function selected or system status.

For details on the indications, refer to "LED Indicators" (page 28).

About touch keys

The touch keys work when you touch them lightly. Do not press on them with excessive force.

Rear panel

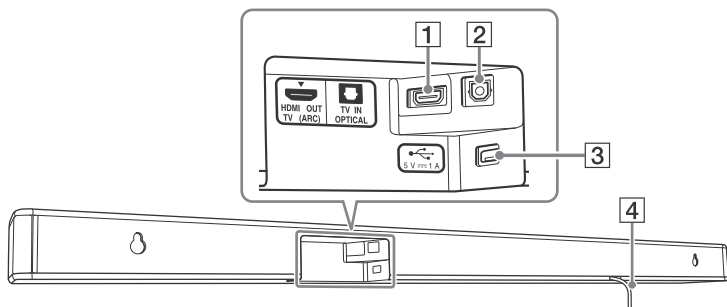

- 1** HDMI OUT TV (ARC) jack
- 2** TV IN OPTICAL jack

- 3**  (USB) port (page 13)
- 4** AC power cord (mains lead)

Subwoofer

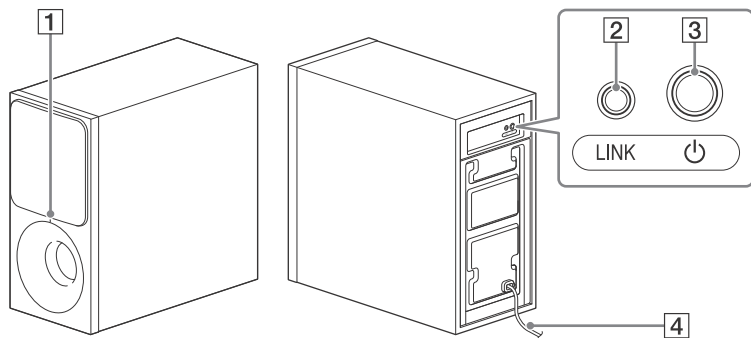

1 Power indicator

- Lights off: Power is off
- Lights up:
 - Red: The subwoofer is in standby mode
 - Green: The subwoofer is connected to the Bar Speaker without Secure Link
 - Orange: The subwoofer is connected to the Bar Speaker with Secure Link
- Flashes:
 - Green (fast): The subwoofer is searching for the Bar Speaker to connect
 - Green: The subwoofer is attempting to connect with the Bar Speaker without Secure Link
 - Orange: The subwoofer is attempting to connect with the Bar Speaker with Secure Link
 - Red: The subwoofer detects an abnormality. See “Subwoofer wireless sound” in “Troubleshooting” (page 25).

2 LINK (Secure Link) (page 20)

3 (power)

Turns on the subwoofer or sets it to standby mode.

4 AC power cord (mains lead)

About the standby mode

The subwoofer enters standby mode automatically and the power indicator turns red when the Bar Speaker is in standby mode or wireless transmission is deactivated. The subwoofer turns on automatically when the Bar Speaker is turned on and wireless transmission is activated.

Remote control

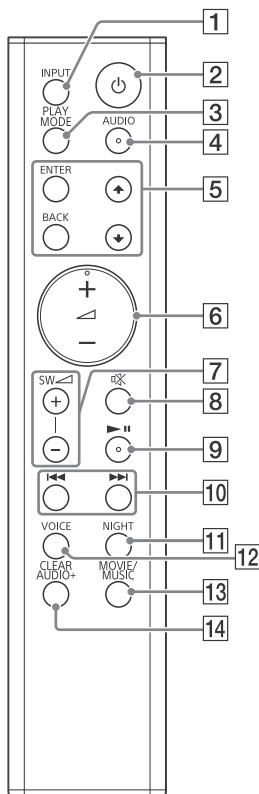

1 INPUT (page 12)

2 (power)

Turns on the system or sets it to standby mode.

3 PLAY MODE (page 13)

Also used for turning on or off the attenuation function (page 15).

4 AUDIO* (page 15)

Also used for turning on or off the Dolby DRC function (page 15).

5 ENTER

Enters the selection.



Selects the folder or file in a USB device.

BACK

Returns to the previous display.

Stops USB playback.

Also used for turning on or off the LED indicators (page 28).

6 (volume) +*/-

Adjusts the volume.

The current input indicator flashes once each time you adjust the volume.

The USB, TV and BT indicators flash three times when you adjust the volume to maximum or minimum.

7 SW (subwoofer volume) +/- (page 16)

The current input indicator flashes once each time you adjust the subwoofer volume.

The USB, TV and BT indicators flash three times when you adjust the subwoofer volume to maximum or minimum.

8 (muting)

Turns off the sound temporarily.

The USB, TV and BT indicators flash continuously when the muting function is on.

9 (play/pause)

Pauses or resumes playback.

10 (previous/next/rewind/fast forward)

Press to select the previous/next track or file.

Hold down to search backward or forward.

11 NIGHT (page 14)

Also used for turning on or off the BLUETOOTH standby mode (page 17).

12 VOICE (page 15)



Also used for turning on or off the Control for HDMI function (page 18).

13 MOVIE/MUSIC (page 14)

Also used for turning on or off the auto standby function (page 20).

14 CLEAR AUDIO+ (page 14)

Also used for entering the Secure Link mode (page 20).

* The AUDIO, , +, and  buttons have a tactile dot. Use it as a guide during operation.

Installing the system

Basic connections and preparation

Refer to Startup Guide (separate document).

Mounting the Bar Speaker on a wall

You can mount the Bar Speaker on a wall.

Note

- Prepare screws (not supplied) that are suitable for the wall material and strength. As a plasterboard wall is especially fragile, attach the screws securely to two studs in the wall beam. Install the Bar Speaker horizontally, hung by screws in studs in a continuous flat section of the wall.
- Be sure to subcontract the installation to Sony dealers or licensed contractors and pay special attention to safety during the installation.
- Sony shall not be held responsible for accidents or damage caused by improper installation, insufficient wall strength, improper screw installation or natural calamity, etc.

- 1 Prepare screws (not supplied) that are suitable for the holes on the rear of the Bar Speaker.**

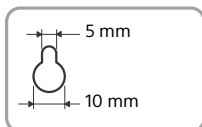
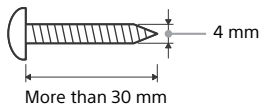

Hole on the rear of the Bar Speaker

- 2 Stick the WALL MOUNT TEMPLATE (supplied) on a wall.**

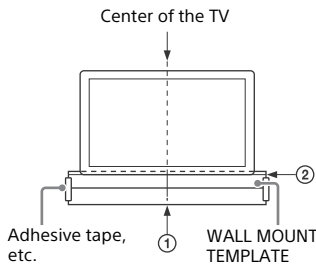

- 1** Align TV CENTER LINE (①) of the WALL MOUNT TEMPLATE with the center line of your TV.
- 2** Align TV BOTTOM LINE (②) of the WALL MOUNT TEMPLATE with the bottom of your TV.
- 3** Stick the WALL MOUNT TEMPLATE on the wall using a commercially available adhesive tape, etc.

- 3 Mark the screw positions on the SCREW LINE (③) of the WALL MOUNT TEMPLATE.**

Measure the distance described below with a scale, then mark using a pencil, etc.

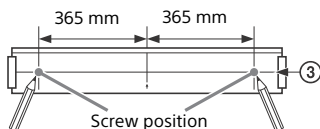

- 4 Fasten the screws into the marks.**
The screws should protrude by 7.5 mm to 8.5 mm.

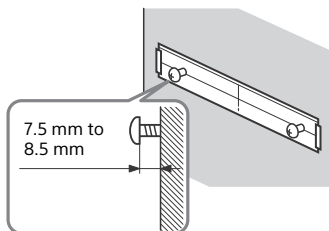

- 5 Remove the wall mount template.**
- 6 Hang the Bar Speaker on the screws.**

Align the holes on the rear of the Bar Speaker with the screws, then hang the Bar Speaker on the two screws.

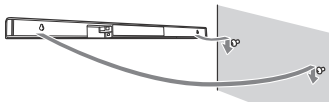

Note

- Smoothen the surface of the wall mount template when sticking it on a wall.
- Keep sufficient space under the Bar Speaker when you hang it on a wall for easy access to the  (USB) port.

Installing the subwoofer horizontally

Place the subwoofer on the right side with the "SONY" logo facing front.

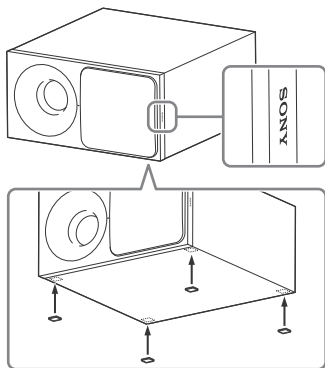

Attach the speaker pads (supplied).

Listening to the sound

Listening to sound from the connected devices

Press INPUT repeatedly.

When you press INPUT once, the current input indicator flashes.

Press INPUT again to select the device you want.

The indicator of the selected device lights up.

Each time you press INPUT, the device changes cyclically as follows.

"TV" → "BT" → "USB"

"TV"

- TV that is connected to the TV IN OPTICAL jack
- TV compatible with the Audio Return Channel (ARC) function that is connected to the HDMI OUT TV (ARC) jack

"BT"

BLUETOOTH device that supports A2DP (page 16)

"USB"

USB device that is connected to the  (USB) port (page 12)

Listening to music from a USB device

You can play music files stored on a connected USB device.

For playable types of files, see "Playable types of files" (page 27).

Note

- To view the USB content list on the TV screen, make sure you connect the system to the TV using HDMI cable.
- Change the input of the TV to the input which the Bar Speaker is connected.

1 Connect the USB device to the **USB** port.

Refer to the operating instructions of the USB device before connecting.

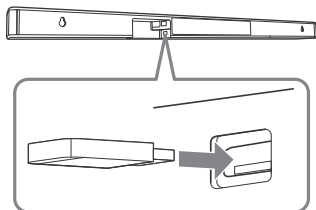

The USB indicator flashes continuously when reading the USB device.

2 Press **INPUT** repeatedly to select "USB".

The USB content list appears on the TV screen.

3 Press **▲/▼** to select the content you want, then press **ENTER**.

The selected content starts playing.

4 Press **PLAY MODE** repeatedly to select the play mode you want.

- None: Plays back all tracks.
 - (Repeat One): Repeats one track.
 - (Repeat Folder): Repeats all tracks in a folder.
 - (Random): Repeats all tracks in a folder in random order.
 - (Repeat All): Repeats all tracks.
- The USB indicator flashes three times each time you press **PLAY MODE**.

5 Adjust the volume.

- Press +/- to adjust the Bar Speaker volume.
- Press **SW** +/- to adjust the subwoofer volume.

Other operations

To	Do this
Stop playback or return to previous display	Press BACK
Pause or resume playback	Press ▶
Select the previous or next track	Press ◀◀/▶▶
Search backward or forward (rewind/fast forward)	Hold down ◀◀/▶▶

Note

- Do not remove the USB device during operation. To avoid data corruption or damage to the USB device, turn off the system before removing the USB device.
- The USB indicator flashes twice continuously if you connect an unsupported USB device.

Information of USB device on the TV screen

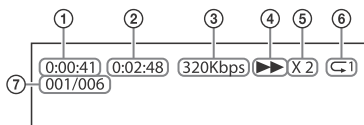

- ① Playing time
- ② Total playing time
- ③ Bit rate
- ④ Playback status
- ⑤ Rewind/fast forward speed
- ⑥ Repeat play status
- ⑦ Selected file index/Total files in the folder

Note

- Depending on the playback source, some information may not be displayed.
- Depending on the play mode, the information displayed may be different.

Sound Adjustment

Enjoying sound effects

You can easily enjoy pre-programmed sound effects that are tailored to different kinds of sound sources.

Selecting the sound effect

Press **MOVIE/MUSIC** repeatedly or **CLEAR AUDIO+** during playback.

CLEAR AUDIO+

You can enjoy the sound with Sony-recommended sound field. Sound field is automatically optimized according to playback content and function. The MOVIE and MUSIC indicators light up for 2 seconds, then light off.

MOVIE

Sound effects are optimized for movies. This mode replicates the density and rich expanse of sound. The MOVIE indicator lights up.

MUSIC

Sound effects are optimized for music. The MUSIC indicator lights up.

Using the Night mode function (NIGHT)

This function is useful when watching movies late at night. You will be able to hear the dialog clearly even at a low volume level.

Press NIGHT.

The MOVIE and MUSIC indicators flash twice.

To turn off this function, press NIGHT again. The MOVIE indicator flashes twice.

Note

This function is set to off automatically when you turn off the system.

Using the Clear Voice function (VOICE)

This function helps make dialogs clearer.

Press VOICE.

The MOVIE and MUSIC indicators flash twice.

To turn off this function, press VOICE again.

The MOVIE indicator flashes twice.

Selecting multiplex broadcast sound (Dual Mono)

You can enjoy multiplex broadcast sound when the system receives a Dolby Digital multiplex broadcast signal.

Press AUDIO repeatedly.

The channel changes cyclically as follows.

Main → Sub → Main/Sub

Main

Outputs only the main channel.
The MOVIE and MUSIC indicators flash twice.

Sub

Outputs only the sub channel.
The MOVIE indicator flashes twice.

Main/Sub

Main sound is output from the left speaker and sub sound is output from the right speaker.
The MUSIC indicator flashes twice.

Setting Dolby DRC (Dynamic Range Control)

Useful for enjoying movies at low sound volume. DRC applies to Dolby Digital sources.

Hold down AUDIO for 5 seconds to turn on or off Dolby DRC.

On

Compresses sound in accordance with the information contained in the content.
The USB and TV indicators flash twice.

Off

Sound is not compressed.
The USB indicator flashes twice.

Setting the Attenuation function

Distortion may occur when you listen to a device connected to the HDMI OUT TV (ARC) or TV IN OPTICAL jack. You can prevent distortion by attenuating the input level on the system.

Hold down PLAY MODE for 5 seconds to turn on or off the attenuation function.

On

Attenuates the input level. The output level will decrease at this setting.
The USB and TV indicators flash twice.

Off

Normal input level.
The USB indicator flashes twice.

Tip

Turn off this function if the sound output from the system is low.

Adjusting the subwoofer volume

The subwoofer is designed for playback of bass or low frequency sound.

Press SW \triangleleft +/- to adjust the subwoofer volume.

The current input indicator flashes once each time you adjust the subwoofer volume.

Note

When the input source does not contain much of bass sound, such as in TV programs, the sound from the subwoofer may be difficult to hear.

BLUETOOTH Functions

Listening to music from a BLUETOOTH device

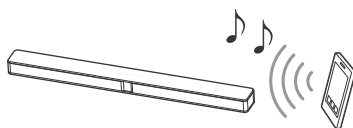

Pairing this system with a BLUETOOTH device

Pairing is an operation where BLUETOOTH devices register with each other beforehand. Once a pairing operation is performed, it does not need to be performed again.

- 1 Place the BLUETOOTH device within 1 meter from the Bar Speaker.**
- 2 Press  (pairing) on the Bar Speaker.**

The system enters the pairing mode. The BLUETOOTH indicator (blue) on the Bar Speaker flashes quickly.
- 3 Turn on the BLUETOOTH function on the BLUETOOTH device, search for devices and select "HT-CT290/291".**

If a Passkey is required, enter "0000".
Perform this step within 5 minutes, otherwise pairing mode may be canceled.

4 Make sure that the BLUETOOTH indicator on the Bar Speaker lights up in blue.

Connection has been established.

Note

- Passkey may be called “Passcode”, “PIN code”, “PIN number” or “Password”.
- You can pair up to 10 BLUETOOTH devices. If the 11th BLUETOOTH device is paired, the least recently connected device will be replaced by the new one.

Listening to music from the paired device

1 Turn on the BLUETOOTH function of the paired BLUETOOTH device.

2 Press INPUT repeatedly to select “BT”.

The system automatically reconnects to the BLUETOOTH device it was most recently connected to.

When the BLUETOOTH connection is established, the BLUETOOTH indicator on the Bar Speaker lights up in blue.

3 Start playback on the BLUETOOTH device.

4 Adjust the volume.

- Adjust the volume of the BLUETOOTH device.
- Press \triangleleft +/- to adjust the Bar Speaker volume.
- Press SW \triangleleft +/- to adjust the subwoofer volume.

Note

- Once the system and the BLUETOOTH device are connected, you can control playback by pressing $\blacktriangleright \parallel$ and $\blacktriangleleft \blacktriangleright$.

- You can connect to the system from a paired BLUETOOTH device even when the system in standby mode, if you set the BLUETOOTH standby mode to on (page 17).
- The audio playback on this system may be delayed from that on the BLUETOOTH device because of the characteristics of the BLUETOOTH wireless technology.

To disconnect the BLUETOOTH device

Perform any of the following items.

- Press Ⓚ (pairing) on the Bar Speaker again.
- Disable the BLUETOOTH function on the BLUETOOTH device.
- Turn off the system or the BLUETOOTH device.

Setting the BLUETOOTH standby mode

When the system has pairing information, you can turn on the system and listen to music from a BLUETOOTH device even when the system is in standby mode by setting the BLUETOOTH standby mode to on.

Hold down NIGHT for 5 seconds to turn on or off the BLUETOOTH standby mode.

On

The USB and TV indicators flash twice.

Off

The USB indicator flashes twice.

Note

During BLUETOOTH standby mode, standby power consumption increases.

Other Functions

Using the Control for HDMI function

Connecting a device such as a TV or Blu-ray Disc player compatible with the Control for HDMI function* by HDMI cable (High Speed HDMI Cable with Ethernet, not supplied) enables you to easily operate the device by a TV remote control.

The following functions can be used with the Control for HDMI function.

- System Power Off function
- System Audio Control function
- Audio Return Channel
- One-Touch Play function

* Control for HDMI is a standard used by CEC (Consumer Electronics Control) for allowing HDMI (High-Definition Multimedia Interface) devices to control each other.

Note

These functions may work with devices other than those manufactured by Sony, but operation is not guaranteed.

Preparing to use the Control for HDMI function

Hold down VOICE for 5 seconds to turn on or off the Control for HDMI function.

On

The USB and TV indicators flash twice.

Off

The USB indicator flashes twice.

Enable the Control for HDMI function settings for the TV and other device connected to the system.

Tip

If you enable the Control for HDMI ("BRAVIA" sync) function when using a TV manufactured by Sony, the Control for HDMI function of the system is also enabled automatically.

System Power Off function

When you turn off the TV, the system will turn off automatically.

System Audio Control function

If you turn on the system while you are watching the TV, the TV sound will be output from the speakers of the system. The volume of the system can be adjusted using the TV's remote control. If the TV sound was output from the speakers of the system the previous time you watched the TV, the system will be turned on automatically when you turn on the TV again. Operations can also be made by the TV's menu. For details, refer to the operating instructions of your TV.

Note

- Sound is only output from the TV if other than "TV" input is selected when using the Twin Picture function on the TV. When you disable the Twin Picture function, the sound is output from the system.
- Depending on the settings of the TV, the System Audio Control function may not be available. For details, refer to the operating instructions of your TV.

Audio Return Channel

If the system is connected to a TV's HDMI IN jack compatible with Audio Return Channel, you can listen to TV sound from the speakers of the system without connecting an optical digital cable.

Note

If the TV is not compatible with Audio Return Channel, an optical digital cable needs to be connected (Refer to the supplied Startup Guide).

One-Touch Play function

When you play content on a device (Blu-ray Disc player, "PlayStation®4", etc.) connected to the TV, the system and TV are turned on automatically, the input of the system is switched to the input for the TV, and sound is output from the speakers of the system.

Note

- If the TV sound was output from the speakers of the TV the previous time you watched the TV, the system does not turn on and the sound and picture are output from the TV even if device content is played.
- Depending on the TV, the beginning part of content being played may not play correctly.

Using the "BRAVIA" Sync function

In addition to the Control for HDMI function, you can also use the following function on devices compatible with the "BRAVIA" sync function.

- Scene Select function

Note

This function is proprietary function of Sony. This function cannot operate with products other than those manufactured by Sony.

Scene Select function

The sound field of the system is automatically switched according to the TV's Scene Select or Sound Mode function settings. For details, refer to the operating instructions of your TV. Set the sound field to "CLEAR AUDIO+" (page 14).

Notes on HDMI connections

- Use a High Speed HDMI cable. If you use a Standard HDMI cable, 1080p content may not be displayed properly.
- Use an HDMI-authorized cable.
- Use a Sony High Speed HDMI cable with the Cable Type Logo.
- We do not recommend using an HDMI-DVI conversion cable.
- Check the setup of the connected equipment if an image is poor or the sound does not come out of the equipment connected via the HDMI cable.
- Audio signals (sampling frequency, bit length, etc.) transmitted from an HDMI jack may be suppressed by the connected device.
- Sound may be interrupted when the sampling frequency or the number of channels of audio output signals from the playback equipment is switched.

- If the connected equipment is not compatible with copyright-protection technology (HDCP), the image and/or the sound from the HDMI OUT jack of this system may be distorted or may not be output. In such a case, check the specifications of the connected equipment.

Auto standby function

The system enters standby mode automatically when you do not operate the system for about 20 minutes and the system is not receiving an input signal.

Hold down MOVIE/MUSIC for 5 seconds to turn on or off the auto standby function.

On

The USB and TV indicators flash twice.

Off

The USB indicator flashes twice.

When the system enters standby mode, all LED indicators except BLUETOOTH indicator (blue) flash slowly.

Activating wireless transmission between specific units (Secure Link)

You can specify the wireless connection to link the Bar Speaker to the subwoofer using the Secure Link function. This function can help prevent interference if you use multiple wireless products.

1 Press LINK on the rear of the subwoofer.

The power indicator on the subwoofer flashes in orange.

2 Hold down CLEAR AUDIO+ for 5 seconds.

The USB and TV indicators flash two times, then the MOVIE and MUSIC indicators flash alternately.

When the Bar Speaker is linked to the subwoofer, the indicators stop flashing and the power indicator on the subwoofer lights up in orange. If it failed, the indicators light up for 5 seconds. Try again the above operation.

To deactivate this function, hold down CLEAR AUDIO+ for 5 seconds.

The USB indicator flashes twice.

Precautions

On safety

- Should any solid object or liquid fall into the system, unplug the system and have it checked by qualified personnel before operating it any further.
- Do not touch the AC power cord (mains lead) with wet hands. Doing so may cause an electric shock.
- Do not climb on the Bar Speaker and subwoofer, as you may fall down and injure yourself, or system damage may result.

On power sources

- Before operating the system, check that the operating voltage is identical to your local power supply. The operating voltage is indicated on the nameplate at the rear of the Bar Speaker and the subwoofer.
- If you are not going to use the system for a long time, be sure to disconnect the system from the wall outlet (mains). To disconnect the AC power cord (mains lead), grasp the plug itself; never pull the cord.
- AC power cord (mains lead) must be changed only at a qualified service shop.

On heat buildup

Although the system heats up during operation, this is not a malfunction. If you continuously use this system at high volume, the system temperature at the rear and bottom rises considerably. To avoid burning yourself, do not touch the system.

On placement

- Sufficient space around the system is needed to release heat. When placing the subwoofer in a rack, leave more than 5 cm space above the subwoofer, and more than 5 cm space along the sides of the subwoofer. The rack behind the subwoofer should be open. If you place the subwoofer with its back against the wall, leave more than 10 cm space between the subwoofer and the wall.
- Leave the front of the system open.
- Place the system in a location with adequate ventilation to prevent heat buildup and prolong the life of the system.
- Do not place the system in locations that are subject to vibration (for example, unstable rack, etc.).
- Do not place the subwoofer in a rack that could interfere with the wireless function (for example, metal rack, etc.).
- Do not place the system near heat sources or in a place subject to direct sunlight, excessive dust, or mechanical shock.
- Do not place anything at the rear of the Bar Speaker and subwoofer that might block the ventilation holes and cause malfunctions.
- If the system is used with a TV, VCR, or tape deck, noise may result and picture quality may suffer. In this case, place the system away from the TV, VCR, or tape deck.
- Use caution when placing the system on a surface that has been specially treated (with wax, oil, polish, etc.), as staining or discoloration of the surface may result.
- Take care to avoid any possible injury from the corners of the Bar Speaker and subwoofer.

On handling the subwoofer

Do not place your hand into the slit of the subwoofer when lifting it. The speaker driver may be damaged. When lifting it, hold the bottom of the subwoofer.

On operation

Before connecting other device, be sure to turn off and unplug the system.

If you encounter color irregularity on a nearby TV screen

Color irregularities may be observed on certain types of TV.

- If color irregularity is observed...
Turn off the TV, then turn it on again after 15 to 30 minutes.
- If color irregularity is observed again...
Place the system further away from the TV.

On cleaning

Clean the system with a soft, dry cloth. Do not use any type of abrasive pad, scouring powder, or solvent such as alcohol or benzene.

If you have any question or problem concerning your system, please consult your nearest Sony dealer.

Troubleshooting

If you experience any of the following difficulties while using the system, use this troubleshooting guide to help remedy the problem before requesting repairs. Should any problem persist, consult your nearest Sony dealer. Be sure to bring both your Bar Speaker and subwoofer, even if it seems as though only one has a problem, when you request to repair.

General

The power does not turn on.

- Check that the AC power cord (mains lead) is connected securely.

The system does not work normally.

- Disconnect the AC power cord (mains lead) from the wall outlet (mains), then reconnect after several minutes.

The system is turned off automatically.

- The auto standby function is working (page 20).

The system does not turn on even when the TV is turned on.

- Activate the Control for HDMI function (page 18). The TV must support the Control for HDMI function (page 18). For details, refer to the operating instructions of your TV.
- Check the speaker settings of the TV. The system power syncs with the speaker settings of the TV. For details, refer to the operating instructions of your TV.
- If the sound was output from the speakers of the TV the previous time, the system does not turn on even when the TV is turned on. Turn on the system and switch the input of the system to "TV" (page 12).

The system turns off when the TV is turned off.

- The system turns off automatically when you turn off the TV if the system is in "TV" input.

The system does not turn off even when the TV is turned off.

- The system does not turn off automatically when you turn off the TV if the system is in "USB" or "BT" input.

Sound

No TV sound is output from the system.

- Check the type and connection of the HDMI cable or optical digital cable that is connected to the system and the TV (refer to the supplied Startup Guide).
- If your TV is compatible with Audio Return Channel, make sure the system is connected to an HDMI (ARC) jack of a TV (refer to the supplied Startup Guide). If sound is still not output or if sound is interrupted, connect the supplied optical digital cable.
- If your TV is not compatible with Audio Return Channel, TV sound will not be output from the system even if the system is connected to the TV's HDMI input jack. To output TV sound from the system, connect the supplied optical digital cable (refer to the supplied Startup Guide).
- Switch input of the system to "TV" (page 12).
- Increase the volume on the system or cancel muting.
- Depending on the order in which you connect the TV and the system, the system may be muted. USB, TV and BT indicators flash continuously in this condition. If this happens, turn on the TV first, then the system.
- Set the speakers setting of the TV (BRAVIA) to Audio System. Refer to the operating instructions of your TV regarding how to set the TV.
- Depending on the TV and the playback sources, sound may not be output from the system. Set the audio format setting of the TV to "PCM". For details, refer to the operating instructions of your TV.

The sound is output from both the system and the TV.

- Mute the sound of the system or the TV.

No sound or only a very low-level sound of the device connected to the system is heard.

- Press \blacktriangleleft + to increase the volume level (page 9).
- Press \times or \blacktriangleleft + to cancel the muting function (page 9).
- Make sure the input source is selected correctly. You should try other input sources by pressing INPUT repeatedly (page 12).
- Set the Attenuation function to off (page 15).
- Check that all the cables and cords of the system and the connected device are firmly inserted.

No sound or only a very low-level sound is heard from the subwoofer.

- Press SW \blacktriangleleft + to increase the subwoofer volume (page 9).
- Check that the power indicator on the subwoofer lights up in green. If not, refer to "No sound is heard from the subwoofer." in "Subwoofer wireless sound" (page 25).
- A subwoofer is for reproducing bass sound. If the input sources contain very little bass sound components (i.e., a TV broadcast), the sound from the subwoofer may be difficult to hear.
- When you play content compatible with copyright protection technology (HDCP), it is not output from the subwoofer.

The surround effect cannot be obtained.

- Depending on the input signal and the sound field setting, surround sound processing may not work effectively. The surround effect may be subtle, depending on the program or disc.
- To play multi-channel audio, check the digital audio output setting on the device connected to the system. For details, refer to the operating instructions supplied with the connected device.

USB device

The USB device is not recognized.

- Try the following:
 - ① Turn off the system.
 - ② Remove and reconnect the USB device.
 - ③ Turn on the system.
- Check that the USB device is securely connected to the  (USB) port.
- Check if the USB device or a cable is damaged.
- Check if the USB device is on.
- If the USB device is connected via a USB hub, disconnect it and connect the USB device directly to the Bar Speaker.

BLUETOOTH device

BLUETOOTH connection cannot be completed.

- Check that the BLUETOOTH indicator on the Bar Speaker lights up in blue (page 6).
- Check that the BLUETOOTH device to be connected is turned on and the BLUETOOTH function is enabled.
- Move the BLUETOOTH device closer to the Bar Speaker.

- Pair this system and the BLUETOOTH device again. You may need to cancel the pairing with this system using your BLUETOOTH device first.

Pairing cannot be done.



- Move the BLUETOOTH device closer to the Bar Speaker.
- Check that this system is not receiving interference from a wireless LAN device, other 2.4 GHz wireless devices, or a microwave oven. If a device that generates electromagnetic radiation is nearby, move the device away from this system.
- Pairing may not be possible if other BLUETOOTH devices are present around the Bar Speaker. In this case, turn off the other BLUETOOTH devices.

No sound is output from the connected BLUETOOTH device.

- Check that the BLUETOOTH indicator on the Bar Speaker lights up in blue (page 6).
- Move the BLUETOOTH device closer to the Bar Speaker.
- If a device that generates electromagnetic radiation, such as a wireless LAN device, other BLUETOOTH devices, or a microwave oven is nearby, move the device away from this system.
- Remove any obstacle between this system and the BLUETOOTH device or move this system away from the obstacle.
- Reposition the connected BLUETOOTH device.
- Switch the wireless LAN frequency of any nearby Wi-Fi router or PC to 5 GHz range.
- Increase the volume on the connected BLUETOOTH device.

Subwoofer wireless sound

No sound is heard from the subwoofer.

- The power indicator on the subwoofer does not light up.
 - Check that the AC power cord (mains lead) of the subwoofer is connected properly.
 - Press  on the subwoofer to turn on the power.
- The power indicator on the subwoofer flashes slowly in green or lights up in red.
 - Move the subwoofer to a location near the Bar Speaker so that the power indicator on the subwoofer lights up in green.
 - Follow the steps in "Activating wireless transmission between specific units (Secure Link)" (page 20).
- If the power indicator on the subwoofer flashes in red, press  on the subwoofer to turn off the power and check whether the ventilation opening of the subwoofer is blocked or not.
- The subwoofer is designed for playback of bass sound. When the input source does not contain much bass sound, as is the case with most TV programs, the bass sound may not be audible.
- Press SW  + to increase the subwoofer volume (page 16).

Sound skips or has noise.

- If there is a device nearby that generates electromagnetic waves like a wireless LAN or a microwave oven in use, locate the system apart from it.
- If there is an obstacle between the Bar Speaker and the subwoofer, move or remove it.
- Locate the Bar Speaker and the subwoofer as close as possible.

- Switch the wireless LAN frequency of any nearby Wi-Fi router or PC to 5 GHz range.
- Switch the network connection of the TV or Blu-ray Disc Player from wireless to wired.

Remote control

The remote control does not function.

- Point the remote control at the remote control sensor on the Bar Speaker (page 6).
- Remove any obstacles in the path between the remote control and the Bar Speaker.
- Replace both batteries in the remote control with new ones, if they are weak.
- Check that you are pressing the correct button on the remote control.

The TV remote control does not work.

- Install the Bar Speaker so that it does not obstruct the remote control sensor of the TV.

Others

The Control for HDMI function does not work properly.

- Check the connection with the system (refer to the supplied Startup Guide).
- Enable the Control for HDMI function on the TV. For details, refer to the operating instructions of your TV.
- Wait a while, and then try again. If you unplug the system, it will take a while before operations can be made. Wait for 15 seconds or longer, and then try again.
- Check that the devices connected to the system support the Control for HDMI function.

- Enable the Control for HDMI function on the devices connected to the system. For details, refer to the operating instructions of your device.
- The type and number of devices that can be controlled by the Control for HDMI function is restricted by the HDMI CEC standard as follows:
 - Recording devices (Blu-ray Disc recorder, DVD recorder, etc.): up to 3 devices
 - Playback devices (Blu-ray Disc Player, DVD player, etc.): up to 3 devices
 - Tuner-related devices: up to 4 devices
 - Audio system (receiver/headphone): up to 1 device (used by this system)

If all input indicators and sound effect indicators flash quickly (PROTECT mode).

- Press  to turn off the system. After the display turns off, disconnect the AC power cord (mains lead) then check that nothing is blocking the ventilation holes of the Bar Speaker.

All input indicators and sound effect indicators do not light up.

- The indicators are off. Hold down BACK for 5 seconds to turn on the indicators.

Sensors of the TV do not work properly.



- The Bar Speaker may block some sensors (such as the brightness sensor), the remote control receiver of your TV, or the emitter for 3D glasses (infrared transmission) of a 3D TV that supports the infrared 3D glass system or the wireless communication. Move the Bar Speaker away from the TV within a range that allow those parts to operate properly. For the locations of the sensors and remote control receiver, refer to the operating instructions supplied with the TV.

 **does not work.**

- The system may be in demo mode. To cancel demo mode, perform "Reset" (page 26).

Reset

If the system still does not operate properly, reset the system as follows. Be sure to use the touch keys on the Bar Speaker to perform this operation.

- 1 Hold down – (volume down) and  simultaneously for 5 seconds.**
All LED indicators flash three times, then light off.
The settings of the menu and sound fields, etc. return to their initial status.
- 2 Disconnect the AC power cord (mains lead).**
- 3 Connect the AC power cord (mains lead), then press  to turn on the system.**
- 4 Link the system to the subwoofer (page 20).**

Playable types of files

Codec	Extension
MP3 (MPEG-1 Audio Layer III)	.mp3
WMA9 Standard	.wma
LPCM	.wav

Note

- Some files may not play depending on the file format, the file encoding, or the recording condition.
- Some files edited on a PC may not play.
- The system does not play coded files such as DRM and Lossless.
- The system can recognize the following files or folders in USB devices:
 - folder paths up to 128 characters long
 - 200 folders (including the root folder)
 - up to 200 files/folders in a single layer
- Some USB devices may not work with this system.
- The system can recognize Mass Storage Class (MSC) devices.

Supported audio formats

Audio formats supported by this system are as follows.

- Dolby Digital
- LPCM 2ch

LED indicators

You can turn on or off the LED indicators by holding down BACK for 5 seconds. When you turn on this feature, the LED indicators light up or flash depending on the function selected or system status.

If you turn off the LED indicators, only BLUETOOTH indicator (blue) lights up in "BT" function.

Function/Status	Indication
Input (page 12) <ul style="list-style-type: none">• TV• BT• USB	TV indicator lights up BT and BLUETOOTH indicator (blue) lights up USB indicator lights up
USB input (page 12) <ul style="list-style-type: none">• Reading• Unsupported USB device	USB indicator flashes continuously USB indicator flashes two times continuously
Sound effect (page 14) <ul style="list-style-type: none">• MOVIE• MUSIC	MOVIE indicator lights up MUSIC indicator lights up
CLEAR AUDIO+ (page 14)	MOVIE and MUSIC indicators light up for 2 seconds, then light off
Volume maximum/minimum, Subwoofer volume maximum/minimum (page 16)	USB, TV and BT indicators flash three times
Volume up/down, Subwoofer volume up/down	Current input indicator flashes one time
Muting	USB, TV and BT indicators flash continuously
Dual Mono (page 15) <ul style="list-style-type: none">• Main• Sub• Main/Sub	MOVIE and MUSIC indicators flash two times MOVIE indicator flashes two times MUSIC indicator flashes two times
Dolby DRC (page 15), Attenuation (page 15) <ul style="list-style-type: none">• On• Off	USB and TV indicators flash two times USB indicator flashes two times
Night Mode (page 14), Clear Voice (page 15) <ul style="list-style-type: none">• On• Off	MOVIE and MUSIC indicators flash two times MOVIE indicator flashes two times
PLAY MODE (page 13)	USB indicator flashes three times
Control for HDMI (page 18), BLUETOOTH Standby (page 17), Auto standby (page 20) <ul style="list-style-type: none">• On• Off	USB and TV indicators flash two times USB indicator flashes two times
Secure Link (page 20) <ul style="list-style-type: none">• On• Off	USB and TV indicators flash two times, then MOVIE and MUSIC indicators flash alternately until connection is established USB indicator flashes two times

Function/Status	Indication
PROTECT (page 26)	All LED indicators except BLUETOOTH indicator (blue) flash quickly
Enters auto standby mode (page 20)	All LED indicators except BLUETOOTH indicator (blue) flash slowly
Reset (page 26)	All LED indicators flash three times, then light off.

Specifications

Bar Speaker (SA-CT290/ SA-CT291)

Amplifier section

POWER OUTPUT (rated)

Front L + Front R:

30 W + 30 W (at 4 ohms, 1 kHz, 1% THD)

POWER OUTPUT (reference)

Front L/Front R: 100 W (per channel at
4 ohms, 1 kHz)

Inputs

USB

TV IN OPTICAL

Output

HDMI OUT TV (ARC)

HDMI section

Connector

Type A (19pin)

USB section

↔ (USB) port

Type A

BLUETOOTH section

Communication system

BLUETOOTH Specification version 4.2

Output

BLUETOOTH Specification Power
Class 1

Maximum communication range

Line of sight approx. 25 m¹⁾

Frequency band

2.4 GHz band (2.4000 GHz –
2.4835 GHz)

Modulation method

FHSS (Freq Hopping Spread Spectrum)

Compatible BLUETOOTH profiles²⁾

A2DP 1.2 (Advanced Audio Distribution
Profile)

AVRCP 1.6 (Audio Video Remote
Control Profile)

Supported Codecs³⁾

SBC⁴⁾

Transmission range (A2DP)

20 Hz – 20,000 Hz (Sampling
frequency 32 kHz, 44.1 kHz, 48 kHz)

1) The actual range will vary depending on factors such as obstacles between devices, magnetic fields around a microwave oven, static electricity, cordless phone, reception sensitivity, antenna's performance, operating system, software application, etc.

2) BLUETOOTH standard profiles indicate the purpose of BLUETOOTH communication between devices.

3) Codec: Audio signal compression and conversion format

4) Subband Codec

Front L/Front R speaker section

Speaker system

Full range speaker system, Acoustic suspension

Speaker

40 mm × 100 mm cone type × 2

General

Power requirements

Taiwan models only:

120 V AC, 50/60 Hz

Other models:

220 V – 240 V AC, 50/60 Hz

Power consumption

On: 40 W

Standby: 0.5 W or less (Power saving mode)

(When Control for HDMI function and BLUETOOTH Standby mode are set to off)

Standby: 2.8 W or less⁵⁾

(When Control for HDMI function and BLUETOOTH standby mode are set to on)

Dimensions (w/h/d) (approx.)

900 mm × 52 mm × 86 mm

Mass (approx.)

2.3 kg

5) The system will automatically enter Power saving mode when there is no HDMI connection and no BLUETOOTH pairing history.

Subwoofer (SA-WCT290/ SA-WCT291)

POWER OUTPUT (reference)	100 W (per channel at 4 ohms, 100 Hz)
Speaker system	Subwoofer system, Bass reflex
Speaker	130 mm cone type
Power requirements	Taiwan models only: 120 V AC, 50/60 Hz Other models: 220 V – 240 V AC, 50/60 Hz
Power consumption	On: 15 W Standby: 0.5 W or less
Dimensions (w/h/d) (approx.)	170 mm × 342 mm × 362 mm (vertical installation) 342 mm × 172 mm × 362 mm (horizontal installation)
Mass (approx.)	6.3 kg

Wireless transmitter/ receiver section

Frequency band	2.4 GHz (2.4000 GHz – 2.4835 GHz)
Modulation method	FHSS (Freq Hopping Spread Spectrum)

Design and specifications are subject to change without notice.

On BLUETOOTH communication

Supported BLUETOOTH version and profiles

Profile refers to a standard set of functions for various BLUETOOTH product features. See “BLUETOOTH section” in “Specifications” (page 30) for the BLUETOOTH version and profiles supported by this system.

Effective communication range

BLUETOOTH devices should be used within approximately 10 meters (unobstructed distance) of each other. The effective communication range may become shorter under the following conditions.

- When a person, metal object, wall or other obstruction is between the devices with a BLUETOOTH connection.
- Locations where a wireless LAN is installed.
- Around microwave ovens that are in use.
- Locations where other electromagnetic waves are generated.

Effects of other devices

BLUETOOTH devices and wireless LAN (IEEE 802.11b/g) use the same frequency band (2.4 GHz). When you use BLUETOOTH device near a device with wireless LAN capability, electromagnetic interference may occur. This could result in lower data transfer rates, noise, or inability to connect. If this happens, try the following remedies:

- Use this system at least 10 meters away from the wireless LAN device.
- Turn off the power to the wireless LAN device when you use BLUETOOTH device within 10 meters.

- Install this system and BLUETOOTH device as close to each other as possible.
- Noise may occur or the audio may cut off depending on the BLUETOOTH device connected with this system, the communications environment, or surrounding conditions.

Effects on other devices

The radio waves broadcast by this system may interfere with the operation of some medical devices. Since this interference may result in malfunction, always turn off the power on this system and BLUETOOTH device in the following locations:

- In hospitals, on trains, in airplanes, at gas stations, and any place where flammable gasses may be present.
- Near automatic doors or fire alarms.

Note

- This system supports security functions that comply with the BLUETOOTH specification to ensure secure connection during communication using BLUETOOTH technology. However, this security may be insufficient depending on the setting contents and other factors, so always be careful when performing communication using BLUETOOTH technology.
- Sony cannot be held liable in any way for damages or other loss resulting from information leaks during communication using BLUETOOTH technology.
- BLUETOOTH communication is not necessarily guaranteed with all BLUETOOTH devices that have the same profile as this system.
- BLUETOOTH devices connected with this system must comply with the BLUETOOTH specification prescribed by the Bluetooth SIG, Inc., and must be certified to comply. However, even when a device complies with the BLUETOOTH specification, there may be cases where the characteristics or specifications of the BLUETOOTH device make it impossible to connect, or may result in different control methods, display or operation.

HDMI

<http://www.sony.net/>



* 4 6 8 8 2 5 2 2 1 * (1)