

Digital 4K Video Camera Recorder

Digital HD Video Camera Recorder

Operating Guide

Getting started

Recording/Playback

Saving images

Customizing your
camcorder

Others



Please also refer to:

<http://www.sony.net/SonyInfo/Support/>

HANDYCAM®

AVCHD Progressive XAVC S 4K

HDMI™ infoLITHIUM V SERIES

MEMORY STICK™ CLASS 10 SDXC™ N™

Read this first

Before operating the unit, please read this manual thoroughly, and retain it for future reference.

Owner's Record

The model and serial numbers are located on the bottom. Record the serial number in the space provided below. Refer to these numbers whenever you call your Sony dealer regarding this product.

Model No. FDR-

Model No. HDR-

Serial No. _____

Model No. AC- _____

Serial No. _____

WARNING

To reduce the risk of fire or electric shock,

1) do not expose the unit to rain or moisture.

2) do not place objects filled with liquids, such as vases, on the apparatus.

Do not expose the batteries to excessive heat such as sunshine, fire or the like.

IMPORTANT SAFETY INSTRUCTIONS

SAVE THESE INSTRUCTIONS. DANGER - TO REDUCE THE RISK OF FIRE OR ELECTRIC SHOCK, CAREFULLY FOLLOW THESE INSTRUCTIONS.

- Read these instructions.
- Keep these instructions.
- Heed all warnings.
- Follow all instructions.
- Do not use this apparatus near water.
- Clean only with dry cloth.
- Do not block any ventilation openings. Install in accordance with the manufacturer's instructions.
- Do not install near any heat sources such as radiators, heat registers, stoves, or other apparatus (including amplifiers) that produce heat.
- Do not defeat the safety purpose of the polarized or grounding-type plug. A polarized plug has two blades with one wider than the other. A grounding type plug has two blades and a third grounding prong. The wide blade or the third prong are provided for your safety. If the provided plug does not fit into your outlet, consult an electrician

for replacement of the obsolete outlet.

- Protect the power cord from being walked on or pinched particularly at plugs, convenience receptacles, and the point where they exit from the apparatus.
- Only use attachments/accessories specified by the manufacturer.
- Use only with the cart, stand, tripod, bracket, or table specified by the manufacturer, or sold with the apparatus. When a cart is used, use caution when moving the cart/apparatus combination to avoid injury from tip-over.



- Unplug this apparatus during lightning storms or when unused for long periods of time.
- Refer all servicing to qualified service personnel. Servicing is required when the apparatus has been damaged in any way, such as power-supply cord or plug is damaged, liquid has been spilled or objects have fallen into the apparatus, the apparatus has been exposed to rain or moisture, does not operate normally, or has been dropped.
- If the shape of the plug does not fit the power outlet, use an attachment plug adaptor of the proper configuration for the power outlet.

Representative plug of power supply cord of countries/regions around the world.



A Type
(American
Type)



B Type
(British
Type)



BF Type
(British
Type)



B3 Type
(British
Type)



C Type
(CEE
Type)



SE Type
(CEE
Type)



O Type
(Ocean
Type)

The representative supply voltage and plug type are described in this chart. Depend on an area, Different type of plug and supply voltage are used.

Attention: Power cord meeting demands from each country shall be used.

- For only the United States

Use a supplied power cord.

Europe

Countries/regions	Voltage	Frequency (Hz)	Plug type
Austria	230	50	C
Belgium	230	50	C
Czech	220	50	C
Denmark	230	50	C
Finland	230	50	C
France	230	50	C
Germany	230	50	C
Greece	220	50	C
Hungary	220	50	C
Iceland	230	50	C
Ireland	230	50	C/BF
Italy	220	50	C
Luxemburg	230	50	C
Netherlands	230	50	C
Norway	230	50	C
Poland	220	50	C
Portugal	230	50	C
Romania	220	50	C
Russia	220	50	C
Slovak	220	50	C
Spain	127/230	50	C
Sweden	230	50	C
Switzerland	230	50	C
UK	240	50	BF

Asia

Countries/regions	Voltage	Frequency (Hz)	Plug type
China	220	50	A
Hong Kong	200/220	50	BF
India	230/240	50	C
Indonesia	127/230	50	C
Japan	100	50/60	A
Korea (rep)	220	60	C
Malaysia	240	50	BF
Philippines	220/230	60	A/C
Singapore	230	50	BF
Taiwan	110	60	A
Thailand	220	50	C/BF
Vietnam	220	50	A/C

Oceania

Countries/regions	Voltage	Frequency (Hz)	Plug type
Australia	240	50	O
New Zealand	230/240	50	O

North America

Countries/regions	Voltage	Frequency (Hz)	Plug type
Canada	120	60	A
USA	120	60	A

Central America

Countries/regions	Voltage	Frequency (Hz)	Plug type
Bahamas	120/240	60	A
Costa Rica	110	60	A
Cuba	110/220	60	A/C
Dominican (rep)	110	60	A
El Salvador	110	60	A
Guatemala	120	60	A
Honduras	110	60	A
Jamaica	110	50	A
Mexico	120/127	60	A
Nicaragua	120/240	60	A
Panama	110/220	60	A

South America

Countries/regions	Voltage	Frequency (Hz)	Plug type
Argentina	220	50	C/BF/O
Brazil	127/220	60	A/C
Chile	220	50	C
Colombia	120	60	A
Peru	220	60	A/C
Venezuela	120	60	A

Middle East

Countries/regions	Voltage	Frequency (Hz)	Plug type
Iran	220	50	C/BF
Iraq	220	50	C/BF
Israel	230	50	C
Saudi Arabia	127/220	50	A/C/BF
Turkey	220	50	C
UAE	240	50	C/BF

Africa

Countries/regions	Voltage	Frequency (Hz)	Plug type
Algeria	127/220	50	C
Congo (dem)	220	50	C
Egypt	220	50	C
Ethiopia	220	50	C
Kenya	240	50	C/BF
Nigeria	230	50	C/BF
South Africa	220/230	50	C/BF
Tanzania	230	50	C/BF
Tunisia	220	50	C

CAUTION

I Battery pack

If the battery pack is mishandled, the battery pack can burst, cause a fire or even chemical burns. Observe the following cautions.

- Do not disassemble.
- Do not crush and do not expose the battery pack to any shock or force such as hammering, dropping or stepping on it.
- Do not short circuit and do not allow metal objects to come into contact with the battery terminals.
- Do not expose to high temperature above 60°C (140°F) such as in direct sunlight or in a car parked in the sun.
- Do not incinerate or dispose of in fire.
- Do not handle damaged or leaking lithium ion batteries.
- Be sure to charge the battery pack using a genuine Sony battery charger or a device that can charge the battery pack.
- Keep the battery pack out of the reach of small children.
- Keep the battery pack dry.
- Replace only with the same or equivalent type recommended by Sony.
- Dispose of used battery packs promptly as described in the instructions.

Replace the battery with the specified type only. Otherwise, fire or injury may result.

I AC Adaptor

Do not use the AC Adaptor placed in a narrow space, such as between a wall and furniture.

Use the nearby wall outlet (wall socket) when using the AC Adaptor. Disconnect from the AC Adaptor from the wall outlet (wall socket) immediately if any malfunction occurs while using the apparatus.

I Note on the power cord (mains lead)

The power cord (mains lead) is designed specifically for use with this camcorder only, and should not be used with other electrical equipment.

Even if your camcorder is turned off, AC power source (mains) is still supplied to it while connected to the wall outlet (wall socket) via the AC Adaptor.



WARNING

Do not ingest battery, chemical burn hazard.

The remote control supplied with this product contains a coin/button cell battery. If the coin/button cell battery is swallowed, it can cause severe internal burns in just 2 hours and can lead to death.

Keep new and used batteries away from children. If the battery compartment does not close securely, stop using the product and keep it away from children. If you think batteries might have been swallowed or placed inside any part of the body, seek immediate medical attention.

Excessive sound pressure from earphones and headphones can cause hearing loss.

For Customers in the U.S.A. and Canada

RECYCLING LITHIUM-ION BATTERIES

Lithium-Ion batteries are recyclable. You can help preserve our environment by returning your used rechargeable batteries to the collection and recycling location nearest you.



For more information regarding recycling of rechargeable batteries, call toll free 1-800-822-8837, or visit <http://www.call2recycle.org/>

Caution: Do not handle damaged or leaking Lithium-Ion batteries.

Battery pack/AC Adaptor

This device complies with Part 15 of the FCC Rules. Operation is subject to the following two conditions: (1) This device may not cause harmful interference, and (2) this device must accept any interference received, including interference that may cause undesired operation.

CAN ICES-3 B/NMB-3 B

This equipment complies with FCC/IC radiation exposure limits set forth for an uncontrolled environment and meets the FCC radio frequency (RF) Exposure Guidelines in Supplement C to OET65 and RSS-102 of the IC radio frequency (RF) Exposure rules. This equipment has very low levels of RF energy that are deemed to comply without testing of specific absorption ratio (SAR).

For Customers in the U.S.A.

If you have any questions about this product, you may call:

Sony Customer Information Center
1-800-222-SONY (7669).

The number below is for the FCC related matters only.

Regulatory Information

Declaration of Conformity

Trade Name: SONY

Model No.: FDR-AX100

Responsible Party: Sony
Electronics Inc.

Address: 16530 Via Esprillo,
San Diego, CA 92127
U.S.A.

Telephone No.: 858-942-2230

This device complies with Part 15 of the FCC Rules. Operation is subject to the following two conditions: (1) This device may not cause harmful interference, and (2) this device must accept any interference received, including interference that may cause undesired operation.

Declaration of Conformity

Trade Name: SONY

Model No.: HDR-CX900

Responsible Party: Sony
Electronics Inc.

Address: 16530 Via Esprillo,
San Diego, CA 92127
U.S.A.

Telephone No.: 858-942-2230

This device complies with Part 15 of the FCC Rules. Operation is subject to the following two conditions: (1) This device may not cause harmful interference, and (2) this device must accept any interference received, including interference that may cause undesired operation.

This equipment must not be co-located or operated in conjunction with any other antenna or transmitter.

I CAUTION

You are cautioned that any changes or modifications not expressly approved in this manual could void your authority to operate this equipment.

I Note:

This equipment has been tested and found to comply with the limits for a Class B digital device, pursuant to Part 15 of the FCC Rules.

These limits are designed to provide reasonable protection against harmful interference in a residential installation. This equipment generates, uses, and can radiate radio frequency energy and, if not installed and used in accordance with the instructions, may cause harmful interference to radio communications. However, there is no guarantee that interference will not occur in a particular installation. If this equipment does cause harmful interference to radio or television reception, which can be determined by turning the equipment off and on, the user is encouraged to try to correct the interference by one or more of the following measures:

- Reorient or relocate the receiving antenna.
- Increase the separation between the equipment and receiver.
- Connect the equipment into an outlet on a circuit different from that to which the receiver is connected.
- Consult the dealer or an experienced radio/TV technician for help.

The supplied interface cable must be used with the equipment in order to comply with the limits for a digital device pursuant to Subpart B of Part 15 of FCC Rules.

I For the State of California, USA only

Perchlorate Material – special handling may apply,
See

www.dtsc.ca.gov/hazardouswaste/perchlorate

For Customers in Canada

This device complies with Industry Canada licence-exempt RSS standard(s).

Operation is subject to the following two conditions: (1) this device may not cause interference, and (2) this device must accept any interference, including interference that may cause undesired operation of the device.

For Customers in Europe



Hereby, Sony Corporation, declares that this equipment is in compliance with the essential requirements and other relevant provisions of Directive 1999/5/EC. For details, please access the following URL:
<http://www.compliance.sony.de/>

I Notice for the customers in the countries applying EU Directives

Manufacturer: Sony Corporation, 1-7-1 Konan Minato-ku Tokyo, 108-0075 Japan

For EU product compliance: Sony Deutschland GmbH, Hedelfinger Strasse 61, 70327 Stuttgart, Germany

I Notice

If static electricity or electromagnetism causes data transfer to discontinue midway (fail), restart the application or disconnect and connect the communication cable (USB, etc.) again.

This product has been tested and found compliant with the limits set out in the EMC regulation for using connection cables shorter than 3 meters (9.8 feet).

The electromagnetic fields at the specific frequencies may influence the picture and sound of this unit.

I Disposal of waste batteries and electrical and electronic equipment (applicable in the European Union and other European countries with separate collection systems)



This symbol on the product, the battery or on the packaging indicates that the product and the battery shall not be

treated as household waste. On certain batteries this symbol might be used in combination with a chemical symbol. The chemical symbols for mercury (Hg) or lead (Pb) are added if the battery contains more than 0.0005% mercury or 0.004% lead. By ensuring these products and

batteries are disposed of correctly, you will help prevent potentially negative consequences for the environment and human health which could otherwise be caused by inappropriate waste handling. The recycling of the materials will help to conserve natural resources.

In case of products that for safety, performance or data integrity reasons require a permanent connection with an incorporated battery, this battery should be replaced by qualified service staff only. To ensure that the battery and the electrical and electronic equipment will be treated properly, hand over these products at end-of-life to the applicable collection point for the recycling of electrical and electronic equipment. For all other batteries, please view the section on how to remove the battery from the product safely. Hand the battery over to the applicable collection point for the recycling of waste batteries. For more detailed information about recycling of this product or battery, please contact your local Civic Office, your household waste disposal service or the shop where you purchased the product or battery.

For Customers in Singapore

Complies with
IDA Standards
DB00353

Learning more about the camcorder (Help Guide)

Help Guide is an on-line manual. Refer to it for in-depth instructions on the many functions of the camcorder.

1 Access the Sony support page.

<http://www.sony.net/SonyInfo/Support/>



2 Select your country or region.

3 Search for the model name of your camcorder within the support page.

- Check the model name on the bottom of your camcorder.
-
- Several models are covered in this manual. The models available differ depending on the country/region.

Table of Contents

Read this first	2
Learning more about the camcorder (Help Guide)	11
Selecting the recording format for movies	12
Getting started	14
Supplied items	14
Charging the battery pack	15
Turning the power on	18
Inserting a memory card	19
Recording/Playback ...	21
Recording	21
Using the manual adjustment features	25
Playback	28
Viewing images on a TV	31
Saving images	34
Using PlayMemories Home ...	34
Connecting an external media device	35
Using the Wi-Fi function	37
Customizing your camcorder	41
Using the menus	41
Others	44
Precautions	44
Specifications	46
Parts and controls	50
Index	53



Selecting the recording format for movies

The camcorder is compatible with the XAVC S format.

| What is XAVC S?

XAVC S is a recording format that allows high-resolution images, such as 4K, to be highly compressed with MPEG-4 AVC/H.264 and recorded in the MP4 file format. High image quality will be obtained while keeping the data size within a certain level.

Recording formats available and their features

FDR-AX100/AX100E			
		HDR-CX900/CX900E	
	XAVC S 4K	XAVC S HD	AVCHD
Pixels	 3 840 × 2 160	 1 920 × 1 080	 1 920 × 1 080
Bit-rate	60 Mbps	50 Mbps	Max. 28 Mbps
Features	Records images in 4K. Recording in this format is recommended even if you do not have a 4K TV so you will be able to enjoy the benefits of 4K in the future.	Information volume is greater compared to AVCHD, enabling recording of clearer images.	Compatibility with recording devices other than computers is good.

- Bit-rate indicates the quantity of data recorded in a certain period.

Recording format and the available shooting mode

Recording format	XAVC S 4K	XAVC S HD	AVCHD
Shooting mode	Movie	Movie High Speed REC	Movie Smth Slw REC Golf Shot

- You can change the recording format by selecting **[MENU]** → [Image Quality/Size] → **[File Format]**.

Storage method

Recording format	Storage method	Image quality stored at	Page
XAVC S 4K (FDR-AX100/AX100E)	Computer using PlayMemories Home™ software	XAVC S 4K	34
XAVC S HD		XAVC S HD	34
AVCHD	Computer using PlayMemories Home software	AVCHD	34
	External media device	AVCHD	35

- See the following website for the latest storage environment.
<http://www.sony.net/>
- You can store images by connecting to a recorder with an analog AV cable (sold separately). Movies are copied with standard definition image quality.

I To transfer images to a smartphone

You can transfer MP4 images to a smartphone connected to the camcorder via Wi-Fi (page 37). MP4 format is good for uploading to the Internet. When [Dual Video REC] is set to [On], the camcorder records movies in XAVC S 4K format (FDR-AX100/AX100E), XAVC S HD format, or AVCHD format while recording movies in MP4 format at the same time.

Supplied items

The numbers in () indicate the supplied quantity.

All models

- Camcorder (1)
- AC Adaptor (1)

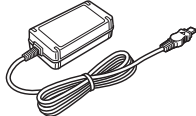

- Power cord (mains lead) (1)

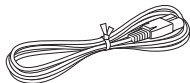

- USB connection support cable (1)

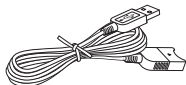

The USB connection support cable is designed for use with this camcorder only. Use this cable when the Built-in USB Cable of the camcorder is too short for connection.

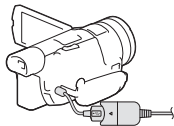

- HDMI cable (1)

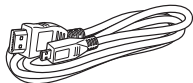

- Lens hood

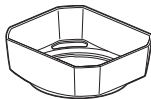

See page 50 on how to attach the lens hood to the camcorder.

- Wireless Remote Commander (1)



- Lens cap (attached to the camcorder) (1)

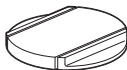

- "Operating Guide" (This manual) (1)

FDR-AX100/AX100E only

- Rechargeable battery pack NP-FV70 (1)



HDR-CX900/CX900E only

- Rechargeable battery pack NP-FV50 (1)

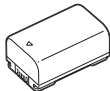

Charging the battery pack

- 1 Turn off your camcorder by closing the LCD monitor, retract the viewfinder, and attach the battery pack.

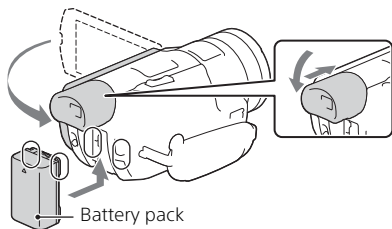

- 2 Connect the AC Adaptor and the power cord (mains lead) to your camcorder and the wall outlet (wall socket).

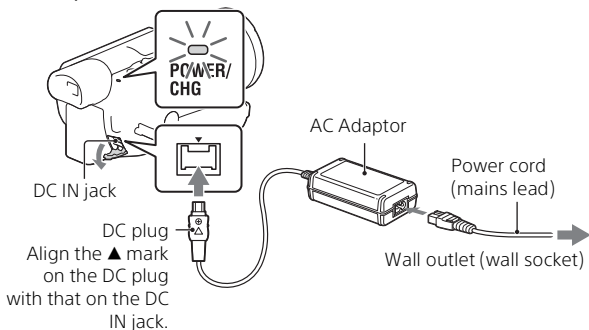

- The POWER/CHG (charge) lamp turns orange.
- The POWER/CHG (charge) lamp turns off when the battery pack is fully charged. Disconnect the AC Adaptor from the DC IN jack of the camcorder.

Charging the battery using your computer

Turn off your camcorder and connect the camcorder to a running computer using the Built-in USB Cable.



Estimated time of charging the supplied battery pack (minutes)

Model	Battery pack	AC Adaptor (supplied)	Computer
FDR-AX100/ AX100E	NP-FV70	205	555
HDR-CX900/ CX900E	NP-FV50	140	305

- The charging times are measured when charging an empty battery pack to its full capacity at a room temperature of 25 °C (77 °F).
- The charging times are measured without using the USB connection support cable.

Estimated time of recording and playback using the supplied battery pack (minutes)

Model	Battery pack	Recording time		Playback time
		Continuous	Typical	
FDR-AX100/ AX100E	NP-FV70	135	65	180
HDR-CX900/ CX900E	NP-FV50	105	50	135

- The recording and playback times are measured when using the camcorder at 25 °C (77 °F).
- The recording times are measured when recording movies with the default settings ([ File Format]: [XAVC S 4K] (FDR-AX100/AX100E). [ File Format]: [AVCHD] (HDR-CX900/CX900E)).
- Typical recording time shows the time when you repeat recording start/stop, switching the [Shooting Mode], and zooming.
- The recording time shows the time when recording with the LCD monitor open.

To use your camcorder connected to the wall outlet (wall socket)

Connect the camcorder to the wall outlet (wall socket) in the same way as "Charging the battery pack."

| To remove the battery pack

Turn off your camcorder. Slide the BATT (battery) release lever (①) and remove the battery pack (②).

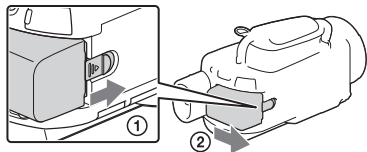

| To charge the battery pack abroad

You can charge the battery pack in any countries/regions using the AC Adaptor supplied with your camcorder within the AC 100 V - 240 V, 50 Hz/60 Hz range.

- Do not use an electronic voltage transformer.

Turning the power on

- 1 Open the LCD monitor of your camcorder and turn the power on.

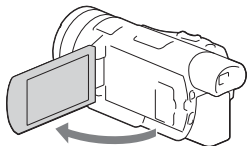

- You can also turn on the camcorder by pulling out the viewfinder.

- 2 Following the instructions on the LCD monitor, select the language, the geographical area, Daylight Savings or Summer Time, date format, and the date and time.

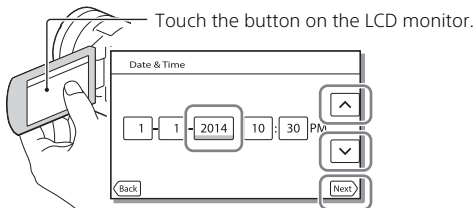

- To go to the next page, touch [Next].

-
- To turn off the power, close the LCD monitor. If the viewfinder is pulled out, retract it.
 - To set the date and time again, select [MENU] → [Setup] → [🕒 Clock Settings] → [Date & Time Setting].
 - To turn off the operating sound, select [MENU] → [Setup] → [🔧 General Settings] → [Beep] → [Off].

Inserting a memory card

- 1 Open the cover, and insert the memory card until it clicks.

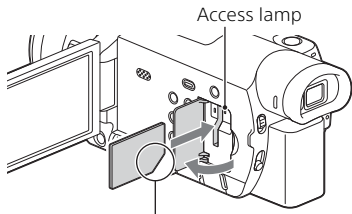

Insert the card with the notched corner in the direction as illustrated.

- The [Preparing image database file. Please wait.] screen appears if you insert a new memory card. Wait until the screen disappears.
-
- To eject the memory card, open the cover and lightly push the memory card in once.

Types of memory card you can use with your camcorder

Recording images in the XAVC S format

	SD Speed Class	Capacity (operation verified)
SDXC memory card	Class 10 or faster	Up to 64 GB

Recording images in a format other than XAVC S

	SD Speed Class	Capacity (operation verified)
SD memory card/SDHC memory card/SDXC memory card	Class 4 or faster	Up to 64 GB
Memory Stick PRO Duo™ (Mark2) media/Memory Stick PRO-HG Duo™ media	–	Up to 32 GB
Memory Stick XC-HG Duo™ media		Up to 64 GB

| To format the recording media

- To ensure stable operation of the memory card, it is recommended to format the memory card with your camcorder before the first use.
- To format the memory card, select **MENU** → [Setup] → [Media Settings] → [Format] → desired recording medium → **OK** .
- Formatting the memory card will erase all the data stored on it and the data will be irrecoverable. Save your important data on your PC, etc.

Notes

- Movies recorded on Memory Stick XC-HG Duo media or SDXC memory cards cannot be imported to or played back on computers or AV devices not supporting the exFAT* file system by connecting the camcorder to these devices with the USB cable. Confirm in advance that the connecting equipment is supporting the exFAT system. If you connect equipment not supporting the exFAT system and the format screen appears, do not perform the format. All the data recorded will be lost.
- * The exFAT is a file system that is used for Memory Stick XC-HG Duo media and SDXC memory cards.

Recording

Recording movies

- 1 Open the LCD monitor, and press START/STOP to start recording.

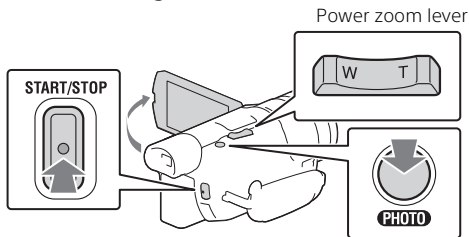

- To stop recording, press START/STOP again.
- Items on the LCD monitor disappear if you do not operate the camcorder for a few seconds. To display items again, touch anywhere except the buttons on the LCD monitor.

Notes

- The zoom speed will become a little slower during movie recording.
- While recording movies in XAVC S 4K format and [30p]/[25p] frame rate, video signals are not output to external media.

| To record MP4 movies simultaneously (Dual Video REC)

When [Dual Video REC] is set to [On], the camcorder records movies in MP4 format while recording movies in XAVC S 4K format (FDR-AX100/AX100E), XAVC S HD format, or AVCHD format at the same time.

Select **[MENU]** → [Image Quality/Size] → [Dual Video REC] → desired setting.

- MP4 format is easy for playing back your movies on a smartphone, for uploading to a network, or for uploading to the Web.

Notes

- When [Dual Video REC] is set to [On], you cannot record photos during movie recording by pressing PHOTO.

| Recording photos during movie recording (Dual Capture)

When [Dual Video REC] is set to [Off], you can record photos during movie recording by pressing PHOTO.

Notes

- You may not be able to shoot photos depending on the setting in [REC Mode] and [Frame Rate].

| Magnifying the image to focus sharply (Focus Magnifier)

Press FOCUS MAGNIFIER (page 50) to enable you to magnify an image at the center of the LCD monitor to check if it is in focus.

- A ▲ appears at each side of the magnified part. Touch a ▲ to move the image in the direction you want.
- Touching the center of the magnified part switches the magnification rate as follows:
Movies: between 2X and 4X
Photos: between 6.3X and 12.6X

Notes

- Even though the image displayed on the camcorder has been magnified, the recorded image is not magnified.



| To suppresses the voice of the person recording the movie (My Voice Canceling)

Press  (My Voice Canceling) (page 51). The voice of the person recording the movie will be suppressed.

Shooting photos

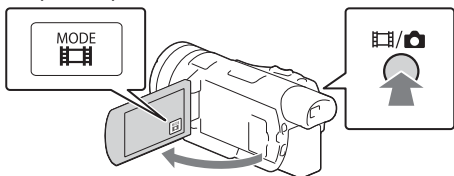
- 1 Open the LCD monitor and select [MODE] →  (Photo).



- You can also switch between  (Movie) and  (Photo) by pressing the  (Shooting Mode) button.

- 2 Press PHOTO lightly to adjust the focus, then press it fully.

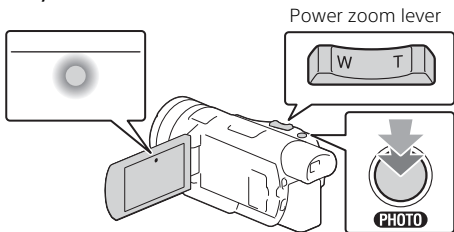

- When the focus is adjusted properly, AE/AF lock indicator appears on the LCD monitor.

Approximate recording time available

Model	Movie format	Memory card (64 GB)
FDR-AX100/AX100E	XAVC S 4K	2 h. 10 min.
HDR-CX900/CX900E	AVCHD HQ	14 h. 25 min.

- When using a Sony memory card.
- When recording with the default settings.
FDR-AX100/AX100E:
[File Format]: [XAVC S 4K], [Audio Mode]: [2ch Stereo], [Dual Video REC]: [Off]
HDR-CX900/CX900E:
[File Format]: [AVCHD], [Audio Mode]: [5.1ch Surround], [Dual Video REC]: [Off]
- The actual recording time or number of recordable photos is displayed on the LCD monitor during recording.

Using the manual adjustment features

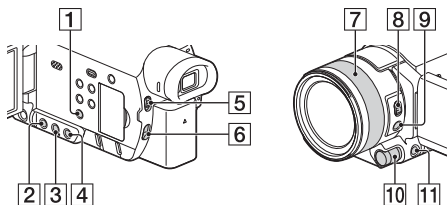

Adjusting the iris (aperture), gain (ISO), or shutter speed

- 1 Press PROGRAM AE **1** to switch iris (aperture), gain (ISO), shutter speed, and exposure to automatic adjustment mode.
- 2 Press IRIS **2**, GAIN/ISO **3** or SHUTTER SPEED **4** to set the respective item to manual adjustment mode.
 - **A** next to the respective setting value disappears, and the value is highlighted.



- 3 Rotate the MANUAL dial **10** to adjust the item manually.
 - You can use the MANUAL dial **10** when the values are highlighted.

| To return to automatic adjustment mode

Press PROGRAM AE **1** again.

- **A** appears next to the respective item, and the value is no longer highlighted.

Adjusting the exposure

When [Exposure] is assigned to the MANUAL dial **[10]**, you can adjust the exposure as follows.

- 1 Press MANUAL **[11]** to switch exposure to manual adjustment mode.

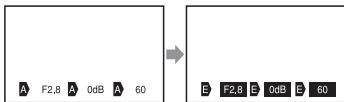

- 2 Rotate the MANUAL dial **[10]** to adjust the exposure.
 - The setting values of iris (aperture), shutter speed and gain (ISO) change as the dial is rotated.
 - You can use the MANUAL dial **[10]** when the values are highlighted.

| To return to automatic adjustment mode

Press MANUAL **[11]** again.

- **A** appears next to each value, and the values are no longer highlighted.

Assigning a menu item to the MANUAL dial

- 1 Press and hold MANUAL **[11]** for a few seconds.
 - The menu items you can control with the MANUAL dial **[10]** will appear on the [Dial Setting] screen.
- 2 Rotate the MANUAL dial **[10]** to select the item to be assigned, and then press MANUAL **[11]**.

| Making the manual adjustment using the MANUAL dial

- ① Press the MANUAL **[11]** to switch to manual adjustment mode.
 - ② Rotate the MANUAL dial **[10]** to make the adjustment.
- To return to automatic adjustment mode, press MANUAL **[11]** again.

Adjusting the light intensity (ND filter)

You can record the subject clearly by using the ND filter function when the recording environment is too bright.

- 1 Set the ND FILTER switch **[5]** to MANUAL, and then select the appropriate ND FILTER position **[6]**.

OFF: Turns off the ND filter function.

1: Reduces light intensity to 1/4.

2: Reduces light intensity to 1/16.

3: Reduces light intensity to 1/64.

Notes

- If you change the ND filter setting during recording, the movie and sound may be distorted.
- When the ND FILTER switch is set to AUTO, select OFF or 1 (1/4) of the ND FILTER position. When you want to select 2 (1/16) or 3 (1/64), set the ND FILTER switch to MANUAL.

Focusing or zooming with the lens ring

You can focus manually, depending on the shooting conditions.

- 1 Press AF/MF **[9]** to switch to manual focusing mode.

-  appears when in manual focusing mode.

- 2 Operate the ZOOM/FOCUS switch **[8]**, and rotate the lens ring **[7]**.

- FOCUS: You can focus manually by turning the lens ring.



- ZOOM: You can zoom by turning the lens ring.

Playback

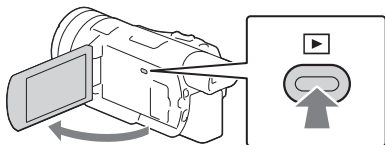
- 1 Open the LCD monitor and press the  (View Images) button on the camcorder to enter the playback mode.



- The Event View screen appears after some seconds.

- 2 Select  /  to move the desired event to the center, and then select the part circled (1) in the figure.

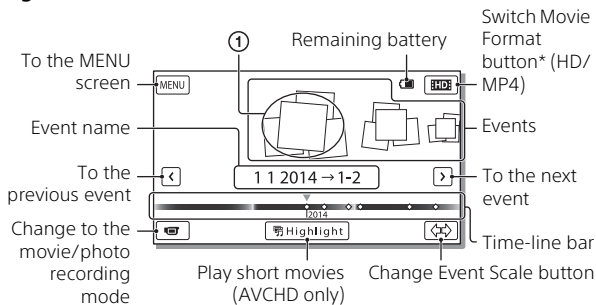

* The icon varies depending on the [ File Format] setting.

- To select the XAVC S movies or AVCHD movies you want to play, edit, or copy to other devices, select **[MENU]** → [Image Quality/Size] → [ File Format].
- You can play movies of the selected frame rate only in the case of XAVC S 4K movies. Select the frame rate according to the movies you want to play.

3 Select the image.

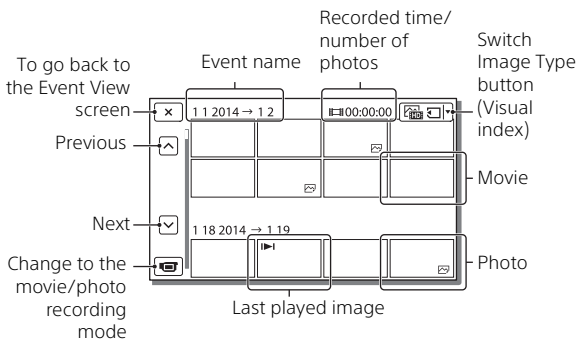

| To switch between movies and photos (Visual index)

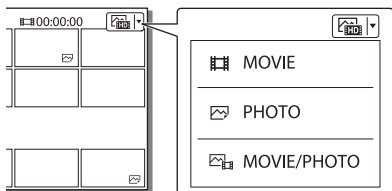

Select the desired type of images.



| Playback operations

	Volume		Previous/Next
	Delete		Fast-reverse/Fast-forward
	Context		Play/Pause
	Stop		Play/Stop slide show

| To delete the images

- ① Select **MENU** → [Image Quality/Size] → [ File Format] → format of images to be deleted.
 - The available format varies depending on the [ File Format] setting.
- ② Select [Edit/Copy] → [Delete] → [Multiple Images] → image type to be deleted.
- ③ Touch and display the **✓** mark on the images to be deleted, then select **OK** .

Viewing images on a TV

Playing back images

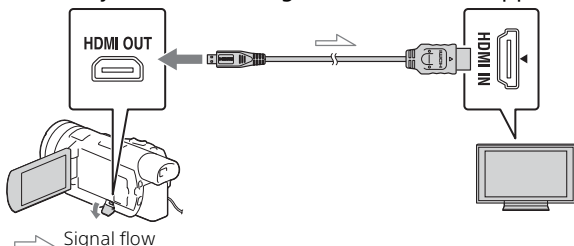

Playable images may be restricted depending on the combination of the movie format at the time of recording, the type of playback images selected on the Event View screen, and the HDMI output settings.

- 1 Connect the HDMI OUT jack of the camcorder to the HDMI IN jack of a TV using the HDMI cable supplied.



How to set the playback images

Movie format	TV	[HDMI Resolution]	Visual index (page 29)	Playback image quality
XAVC S 4K	4K TV	[Auto], [2160p/1080p]	MOVIE PHOTO MOVIE/PHOTO	4K image quality
		[1080p], [1080i], [720p]	MOVIE MOVIE/PHOTO PHOTO	High definition image quality (HD) 4K image quality
	High definition TV	[Auto], [1080p], [1080i], [720p]	MOVIE PHOTO MOVIE/PHOTO	High definition image quality (HD)

Movie format	TV	[HDMI Resolution]	Visual index (page 29)	Playback image quality
XAVC S HD AVCHD	4K TV or High definition TV	[Auto], [2160p/1080p], [1080p], [1080i], [720p]	 MOVIE	High definition image quality (HD)
			 MOVIE/PHOTO	
			 PHOTO	4K image quality (when connected to a 4K TV)

- Images will be played when [HDMI Resolution] is set to [Auto] (default setting).
- If images are not played properly with [Auto], change the [HDMI Resolution] setting. Select **[MENU]** → [Setup] → [↔ Connection] → [HDMI Resolution] → desired setting.
- If your TV does not have an HDMI jack, connect the Multi/Micro USB Terminal of the camcorder to the video/audio input jacks of the TV using an AV cable (sold separately).

Connecting the camcorder to a network-compatible TV

Connect the camcorder to an access point with a security setting (page 40). Press  (View Images) on the camcorder, and then select **[MENU]** → [Edit/Copy] → [View on TV] → image type to be played back.

- You can view AVCHD movies, MP4 movies, and photos only.

Playing back trimmed movies recorded in XAVC S 4K format (FDR-AX100/AX100E)

- 1 Change the HDMI output setting to output 4K movies.
Select [MENU] → [Setup] → [↔ Connection] → [HDMI Resolution] → desired setting.
- 2 Connect the HDMI OUT jack of the camcorder to the HDMI IN jack of a TV using the HDMI cable supplied.

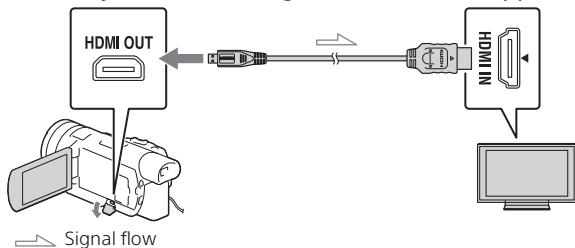

TV	[HDMI Resolution]
4K TV	[Auto]*, [2160p/1080p]*, [1080p], [1080i], [720p]
High definition TV	[Auto], [1080p], [1080i], [720p]

* The screen turns blank for a few seconds when you turn on or off the trimmed movie playback function.

- 3 Touch **ON** (trimming on) on the LCD monitor during playback, and then select the part to be trimmed by touching there.
 - The playback image is trimmed in high definition image quality (HD).

Notes

- Playback of trimmed movies is not available on the LCD monitor of the camcorder.

Using PlayMemories Home

What you can do with PlayMemories Home

PlayMemories Home allows you to import movies and photos to your computer to use them in a variety of ways.

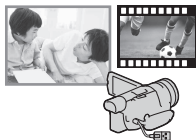

Import images from the camcorder.

For Windows, the following functions are also available.



Viewing images on Calendar



Creating movie discs



Uploading images to network services

Playing back imported images



Sharing images on PlayMemories Online™



| To download PlayMemories Home

PlayMemories Home can be downloaded from the following URL.
www.sony.net/pm/

| To check the computer system

You can check the computer requirements for the software at the following URL.
www.sony.net/pcenv/



Connecting an external media device

How to store AVCHD movies and photos to an external media device is explained here. Also refer to the instruction manual supplied with the external media device.

Store XAVC S movies to a computer using PlayMemories Home software (page 34).

How to store movies

Device	Cable	Stored with	Media
External media device	VMC-UAM2 USB Adaptor Cable (sold separately)	High definition image quality (HD)	External media
Recorder without a USB jack	AV cable (sold separately)	Standard definition image quality	DVD

How to connect a device

External media device

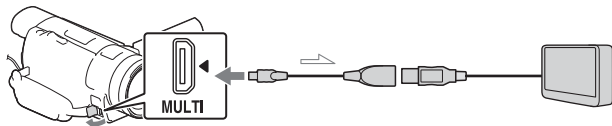

➤ Signal flow

Steps:

- ① Attach the battery to the camcorder.
- ② Connect the AC Adaptor supplied.
- ③ Connect the external media device.

| Recorder without a USB jack

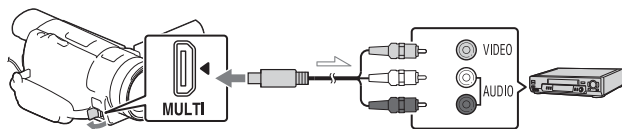

➔ Signal flow

Using the Wi-Fi function

Installing PlayMemories Mobile™ on your smartphone

For the latest information and more detailed information on the functions of PlayMemories Mobile, visit the following URL.



<http://www.sony.net/pmm/>

| Android OS

Install PlayMemories Mobile from Google Play.



- Android 4.0 or higher is required to use One-Touch functions (NFC).

| iOS

Install PlayMemories Mobile from App Store.



- One-touch functions (NFC) are not available with iOS.

Notes

- If PlayMemories Mobile is already installed in your smartphone, update the software to the latest version.
- The Wi-Fi function described here is not guaranteed to work on all smartphones and tablets.
- The Wi-Fi function of the camcorder cannot be used connected to a public wireless LAN.
- To use the One-touch functions (NFC) of the camcorder, a smartphone or tablet supporting the NFC function is required.
- The operation methods and display screens for the application are subject to change without notice by future upgrades.

Transferring MP4 movies and photos to your smartphone

One-touch connection with an Android supporting NFC

- 1 On the smartphone, select [Settings], then, select [More...] to check that [NFC] is enabled.

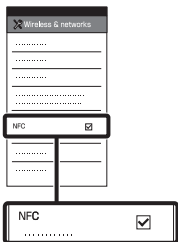

- 2 On the camcorder, play back an image to be sent to the smartphone.
 - You can transfer MP4 movies and photos only.
- 3 Touch the camcorder to the smartphone.

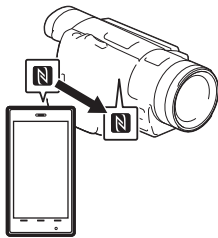

Notes

- Cancel the sleep mode or unlock the screen on the smartphone beforehand.
- Make sure that **N** is displayed on the LCD monitor of the camcorder and the smartphone.
- Continue touching the camcorder to the smartphone without moving until PlayMemories Mobile starts (1 to 2 seconds).
- If the camcorder cannot be connected with the smartphone by NFC, see "Connection without using NFC" (page 38).

Connection without using NFC

- 1 Press the **VIEW IMAGES** (View Images) button, then select **MENU** → [Edit/Copy] → [Send to Smartphone] → [Select on This Device] → image type.
- 2 Select the image you want to transfer, and add **✓**, and then select **OK** → **OK** .
 - The SSID and a password are displayed, and the camcorder is ready to be connected with the smartphone.
- 3 Connect the camcorder to the smartphone, and transfer images.

Android

- ① Start up PlayMemories Mobile and select the SSID of the camcorder.

- Input the password displayed on the camcorder (first time only).

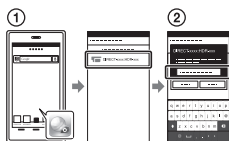

iPhone/iPad

- Select [Settings] → [Wi-Fi] → the SSID displayed on the camcorder.
- Input the password displayed on the camcorder (first time only).
- Confirm that the SSID displayed on the camcorder is selected.
- Return to Home, and start up PlayMemories Mobile.

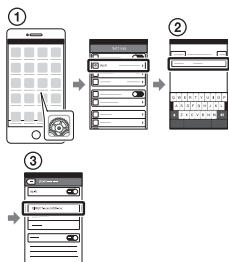

Using your smartphone as a wireless remote commander

You can record with the camcorder using your smartphone as a wireless remote commander.

- On your camcorder, select **MENU** → [Camera/Mic] → [Shooting Assist] → [Ctrl with Smartphone].
- On your smartphone, perform in the same way as in step 3 in "Connection without using NFC" (page 38).
When you use NFC, display the recording screen on your camcorder, and touch **N** on the camcorder to **N** on the smartphone.
- Operate the camcorder on your smartphone.

Notes

- Depending on local electrical interference or the smartphone's capabilities, the live view images may not be displayed smoothly.

Saving movies and photos to your computer via Wi-Fi

Connect your computer to a wireless access point or wireless broadband router in advance.

1 Install the dedicated software in your computer (first time only).

Windows: PlayMemories Home
www.sony.net/pm/

Mac: Wireless Auto Import
<http://www.sony.co.jp/imsoft/Mac/>

- If the software is already installed in your computer, update the software to the latest version.

2 Connect your camcorder to an access point as follows (first time only).

If you cannot register, refer to the instruction of the access point, or contact the person who set up the access point.

If the wireless access point has a WPS button

- ① On your camcorder, select **MENU** → [Setup] → [↔ Connection] → [WPS Push].
- ② Press the WPS button on the access point you want to register.

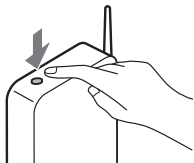

If you know the SSID and the password of your wireless access point

- ① On your camcorder, select **MENU** → [Setup] → [↔ Connection] → [Access point settings].
- ② Select the access point you want to register, enter the password, then select **OK**.

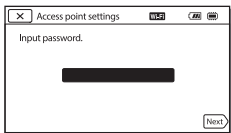

3 If your computer is not started, turn on the computer.

4 Start sending images from the camcorder to the computer.

- ① Press the **▶** (View Images) button on your camcorder.
 - ② Select **MENU** → [Edit/Copy] → [Send to Computer].
- Images are automatically transferred to and saved on the computer.
 - Only newly recorded images are transferred. Importing movies and multiple photos may take time.

Using the menus

- 1 Select **MENU**.



- 2 Select a category.

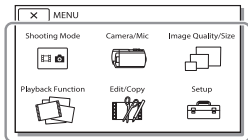

- 3 Select a desired menu item.

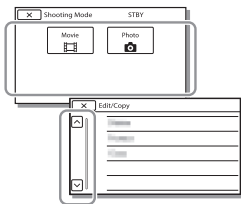

Scroll the menu items up or down.

- Select **X** to finish setting the menu or to return to the previous menu screen.

Menu lists

Shooting Mode

Movie

Photo

Smth Slw REC

Golf Shot

High Speed REC

Camera/Mic

Manual Settings

White Balance

Spot Meter/Fcs

Spot Meter

Spot Focus

Exposure

Focus

AGC Limit

AE Shift

Low Lux

Camera Settings

Scene Selection

Picture Effect

 Cinematone

 Fader

 Self-Timer

 SteadyShot

 SteadyShot

Digital Zoom

Auto Back Light

Dial Setting

NIGHTSHOT Light

 Face

Face Detection

Smile Shutter

Smile Sensitivity

 Flash^{*1}

Flash

Flash Level

Red Eye Reduction

 Microphone

My Voice Canceling

Blt-in Zoom Mic

Auto Wind NR

Audio Mode

Audio Rec Level

 Shooting Assist

Ctrl with Smartphone

My Button

Grid Line

Zebra

Peaking

Camera Data Disp.

Audio Level Display

 Image Quality/Size

REC Mode

Frame Rate

Dual Video REC

File Format

Image Size

 Playback Function

Event View

Scenario

 Edit/Copy

Send to Smartphone

View on TV

Send to Computer

Delete

Protect

Copy

Direct Copy^{*2}

 Setup

Media Settings

Media Info

Format

Repair Img. DB F.

File Number

▶ Playback Settings

Data Code

Volume

Download Music^{*3}

Empty Music^{*3}

↔ Connection

WPS Push

Access point settings

Edit Device Name

Disp MAC Address

SSID/PW Reset

Network Info Reset

TV Type

HDMI Resolution

CTRL FOR HDMI

USB Connect

USB Connect Setting

USB Power Supply

USB LUN Setting

General Settings

Beep

Monitor Brightness

Display Setting

Airplane Mode

REC Lamp

Remote Ctrl

Language Setting

24p Mode^{*4}

Cancel 24p Mode^{*4}

Calibration

Battery Info

Power Save

Initialize

Clock Settings

Date & Time Setting

Area Setting

^{*1} You can set this item when you use a flash (sold separately).

^{*2} You can set this item when you use an external media device (sold separately).

^{*3} FDR-AX100/HDR-CX900

^{*4} FDR-AX100E/HDR-CX900E

Precautions

AC Adaptor

Do not short-circuit the battery terminal with any metallic objects. This may cause a malfunction.

Playing back images with other devices

You may not be able to play back images that were recorded on your camcorder with other devices normally. Also, you may not be able to play back images recorded on other devices with your camcorder.

Recording and playback

- Avoid rough handling, disassembling, modifying, physical shock, or impact such as hammering, dropping or stepping on the product. Be particularly careful with the lens.
- To ensure stable operation of the memory card, it is recommended to format the memory card with your camcorder before the first use. Formatting the memory card will erase all the data stored on it and the data will be irrecoverable. Save your important data on your PC, etc.
- Confirm the direction of the memory card. If you forcibly insert the memory card in the wrong direction, the memory card, memory card slot, or image data may be damaged.
- Before starting to record, test the recording function to make sure the image and sound are recorded without any problems.
- Television programs, films, video tapes, and other materials may

be copyrighted. Unauthorized recording of such materials may be a violation of the copyright laws.

- Compensation for the content of recordings cannot be provided, even if recording or playback is not possible due to a malfunction of the camcorder, recording media, etc.
- The camcorder is not dustproofed, dripproofed or waterproofed.
- Do not let your camcorder get wet, for example, from rain or sea water. If your camcorder gets wet, it may malfunction. Sometimes this malfunction cannot be repaired.
- Do not aim the camcorder at the sun or strong light. Doing so may cause your camcorder to malfunction.
- Do not use the camcorder near strong radio waves or radiation. The camcorder may not be able to record or play back images properly.
- Do not use the camcorder on a sandy beach or anywhere dusty. Doing so may cause your camcorder to malfunction.
- If moisture condensation occurs, stop using the camcorder until moisture evaporates.
- Do not subject the camcorder to mechanical shock or vibration. If you do so, the camcorder may operate incorrectly or may not record images. In addition, the recording medium or recorded data may be damaged.

LCD monitor

The LCD monitor is manufactured using extremely high-precision technology, so over 99.99% of the pixels are operational for effective use. However, there may be some tiny black points and/or bright points (white, red, blue, or green in color) that appear constantly on the LCD monitor. These points are normal results of the manufacturing process and do not affect the recording in any way.

Viewfinder

When no operation has been attempted for a certain amount of time, the viewfinder display will become dark to protect the viewfinder screen burn-in. The viewfinder display will return to normal when you operate the camcorder again.

Camcorder temperature

If you use the camcorder continuously for a long time, the camcorder gets very warm. This is not a malfunction.

Overheat protection

Depending on the camcorder and battery temperature, you may be unable to record movies or the power may turn off automatically to protect the camcorder. A message will be displayed on the LCD monitor before the power turns off or you can no longer record movies. In this case, leave the power off and wait until the camcorder and battery temperature goes down. If you turn on the power without letting the camcorder and battery cool enough, the power may turn off

again or you may be unable to record movies.

Deactivating wireless LAN (Wi-Fi, NFC, etc.) temporarily

When you board an airplane, you can deactivate the Wi-Fi function temporarily. Select **[MENU]** → **[Setup]** → **[ General Settings]** → **[Airplane Mode]** → **[On]**.

Wireless LAN

We assume no responsibility whatsoever for any damage caused by unauthorized access to, or unauthorized use of, destinations loaded on the camcorder, resulting from loss or theft.

Troubleshooting

If you run into any problems using your camcorder:

- Check your camcorder referring to Help Guide (page 11).
- Disconnect the power source, attach the power source again after about 1 minute, and turn the camcorder on.
- Initialize your camcorder (page 43).
All settings, including the clock setting, are reset.
- Contact your Sony dealer or local authorized Sony service facility.

Specifications

System

Signal format:

- FDR-AX100/HDR-CX900: NTSC color, EIA standards
- FDR-AX100E/HDR-CX900E: PAL color, CCIR standards
- FDR-AX100/AX100E: 4K (UHDTV), HDTV
- HDR-CX900/CX900E: HDTV

Movie recording format:

- XAVC S (XAVC S format)
- Video: MPEG-4 AVC/H.264
- Audio: MPEG-4 Linear PCM 2ch (48 kHz/16 bit)
- AVCHD (AVCHD format Ver.2.0 compatible)
- Video: MPEG-4 AVC/H.264
- Audio: Dolby Digital 2ch/5.1ch
- Dolby Digital 5.1 Creator^{*1}
- MP4
- Video: MPEG-4 AVC/H.264
- Audio: MPEG-4 AAC-LC 2ch
- ^{*1} Manufactured under license from Dolby Laboratories.

Photo file format:

- DCF Ver.2.0 Compatible
- Exif Ver.2.3 Compatible
- MPF Baseline Compatible

Viewfinder:

- 1.0 cm (0.39 type) OLED/Color
- 1 440 000 dots equivalent

Recording media (Movie/Photo):

- AVCHD, Photo
- Memory Stick PRO-HG Duo media, Memory Stick XC-HG Duo media, SD card (Class 4 or faster)
- XAVC S
- SDXC Memory Card (Class 10 or faster)

Image device:

- 1.0-type (13.2 mm × 8.8 mm) back-illuminated Exmor R™ CMOS sensor
- Recording pixels (photo, 16:9): Max. 20.0 mega pixels (5 968 × 3 352)^{*2}
- Gross: Approx. 20.9 mega pixels
- Effective (movie, 16:9)^{*3}: Approx. 14.2 mega pixels
- Effective (photo, 16:9): Approx. 14.2 mega pixels
- Effective (photo, 4:3): Approx. 10.6 mega pixels

Lens:

- ZEISS Vario-Sonnar T* Lens
- 12× (Optical)^{*3}, 4K: 18× (FDR-AX100/AX100E) HD: 24× (Clear Image Zoom, while recording movies)^{*4}, 160× (Digital)
- Filter diameter: 62 mm (2 1/2 in.)
- F2.8 - F4.5
- Focal length: f= 9.3 mm - 111.6 mm (3/8 in. - 4 1/2 in.)
- When converted to a 35 mm still camera
- For movies^{*3}: 29.0 mm - 348.0 mm (1 3/16 in. - 13 3/4 in.) (16:9)
- For photos: 29.0 mm - 348.0 mm (1 3/16 in. - 13 3/4 in.) (16:9)
- Color temperature: [Auto], [One Push], [Indoor], [Outdoor], [Color Temp.]
- Minimum illumination: FDR-AX100/HDR-CX900 4K: 6 lx (lux) (FDR-AX100), HD: 3 lx (lux) (in default setting, shutter speed 1/60 second)

4K: 3 lx (lux) (FDR-AX100), HD:
1.7 lx (lux) ([Low Lux] is set to
[On], shutter speed 1/30
second)

NightShot: 0 lx (lux) (shutter
speed 1/60 second)

FDR-AX100E/HDR-CX900E
4K: 6 lx (lux) (FDR-AX100E), HD:
3 lx (lux) (in default setting,
shutter speed 1/50 second)

4K: 3 lx (lux) (FDR-AX100E), HD:
1.7 lx (lux) ([Low Lux] is set to
[On], shutter speed 1/25
second)

NightShot: 0 lx (lux) (shutter
speed 1/50 second)

^{*2} The unique image
processing system of Sony's
BIONZ-X allows still image
resolution equivalent to the
sizes described.

^{*3} [SteadyShot] is set to
[Standard] or [Off].

^{*4} [SteadyShot] is set to
[Active].

Input/Output connectors

HDMI OUT jack: HDMI micro
connector

MIC input jack: Stereo minijack
(ϕ 3.5 mm)

Headphone jack: Stereo minijack
(ϕ 3.5 mm)

USB jack: Type A (Built-in USB)
Multi/Micro USB Terminal*

* Supports Micro USB compatible
devices.

USB connection is only for output
(FDR-AX100E/HDR-CX900E).

LCD monitor

Picture: 8.8 cm (3.5 type, aspect
ratio 16:9)

Total number of pixels: 921 600
(1 920 × 480)

Wireless LAN

Supported standard:
IEEE 802.11 b/g/n

Frequency: 2.4 GHz

Supported security protocols:
WEP/WPA-PSK/WPA2-PSK

Configuration method: WPS (Wi-Fi
Protected Setup)/manual

Access method: Infrastructure
Mode

NFC: NFC Forum Type 3 Tag
compliant

General

Power requirements:

DC 6.8 V/7.2 V (battery pack),
DC 8.4 V (AC Adaptor)

USB Charging: DC 5 V 1 500 mA

Average power consumption:

FDR-AX100/AX100E

During camera recording using
the viewfinder at normal
brightness: 4K: 5.3 W, HD:
3.8 W*

During camera recording using
LCD monitor at normal
brightness: 4K: 5.6 W, HD:
4.0 W*

HDR-CX900/CX900E

During camera recording using
the viewfinder at normal
brightness: HD: 3.2 W*

During camera recording using
LCD monitor at normal
brightness: HD: 3.5 W*

* in AVCHD HQ mode

Operating temperature: 0 °C to
40 °C (32 °F to 104 °F)

Storage temperature: -20 °C to
+60 °C (-4 °F to +140 °F)

Dimensions (approx.):

81 mm × 83.5 mm × 196.5 mm
(3 1/4 in. × 3 3/8 in. × 7 3/4 in.)
(w/h/d) including the
projecting parts

90 mm × 83.5 mm × 223.5 mm
(3 5/8 in. × 3 3/8 in. × 8 7/8 in.)
(w/h/d) including the
projecting parts, the supplied
rechargeable battery pack and
lens hood attached

Mass (approx.):

FDR-AX100/AX100E:

790 g (1 lb 11 oz) main unit only
915 g (2 lb) including the
supplied rechargeable battery
pack NP-FV70 and lens hood
HDR-CX900/CX900E:

790 g (1 lb 11 oz) main unit only
870 g (1 lb 14 oz) including the
supplied rechargeable battery
pack NP-FV50 and lens hood

| AC Adaptor AC-L200D

Power requirements: AC 100 V -
240 V, 50 Hz/60 Hz

Current consumption: 0.35 A -
0.18 A

Power consumption: 18 W

Output voltage: DC 8.4 V*

Operating temperature: 0 °C to
40 °C (32 °F to 104 °F)

Storage temperature: -20 °C to
+60 °C (-4 °F to +140 °F)

Dimensions (approx.):

48 mm × 29 mm × 81 mm
(1 15/16 in. × 1 3/16 in. × 3 1/4
in.)

* See the label on the AC Adaptor
for other specifications.

| Rechargeable battery pack NP-FV70 (FDR-AX100/AX100E)

Maximum output voltage: DC 8.4 V

Output voltage: DC 6.8 V

Maximum charge voltage: DC 8.4 V

Maximum charge current: 3.0 A

Capacity

Typical: 14.0 Wh (2 060 mAh)

Minimum: 13.3 Wh (1 960 mAh)

Type: Li-ion

| Rechargeable battery pack NP-FV50 (HDR-CX900/CX900E)

Maximum output voltage: DC 8.4 V

Output voltage: DC 6.8 V

Maximum charge voltage: DC 8.4 V

Maximum charge current: 2.1 A

Capacity

Typical: 7.0 Wh (1 030 mAh)

Minimum: 6.6 Wh (980 mAh)

Type: Li-ion

Design and specifications of your
camcorder and accessories are
subject to change without notice.

| Trademarks

- AVCHD, AVCHD Progressive, AVCHD logotype and AVCHD Progressive logotype are trademarks of Panasonic Corporation and Sony Corporation.
- Memory Stick and  are trademarks or registered trademarks of Sony Corporation.
- Blu-ray Disc™ and Blu-ray™ are trademarks of the Blu-ray Disc Association.

- Dolby and the double-D symbol are trademarks of Dolby Laboratories.
- The terms HDMI and HDMI High-Definition Multimedia Interface, and the HDMI Logo are trademarks or registered trademarks of HDMI Licensing LLC in the United States and other countries.
- Windows are either registered trademarks or trademarks of Microsoft Corporation in the United States and/or other countries.
- Mac is a registered trademark of Apple Inc. in the United States and other countries.
- Intel, Pentium and Intel Core are trademarks of Intel Corporation in the U.S. and/or other countries.
- SDXC logo is a trademark of SD-3C, LLC.
- Android and Google Play are trademarks of Google Inc.
- iOS is a registered trademark or trademark of Cisco Systems, Inc.
- Wi-Fi, the Wi-Fi logo, Wi-Fi PROTECTED SET-UP are registered trademarks of the Wi-Fi Alliance.
- The N Mark is a trademark or registered trademark of NFC Forum, Inc. in the United States and in other countries.
- Facebook and the “f” logo are trademarks or registered trademarks of Facebook, Inc.
- YouTube and the YouTube logo are trademarks or registered trademarks of Google Inc.
- iPhone and iPad are trademarks of Apple Inc., registered in the U.S. and other countries.

All other product names mentioned herein may be the trademarks or registered trademarks of their respective companies. Furthermore, [™] and [®] are not mentioned in each case in this manual.

Parts and controls

Figures in () are reference pages.

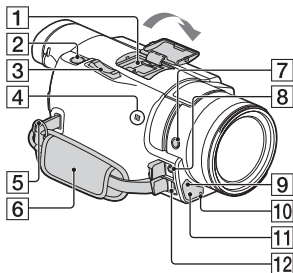

1 Multi interface shoe

ni Multi Interface Shoe

For details on compatible accessories of the Multi interface shoe, visit the Sony web site in your area, or consult your Sony dealer or local authorized Sony service facility.

Operations with other manufacture's accessories are not guaranteed.

If you use a shoe adaptor (sold separately), you can also use accessories compatible with an Active Interface Shoe.

- 2 PHOTO button (23)
- 3 Power zoom lever (21, 23)
- 4 N mark (38)
NFC: Near Field Communication
- 5 Loop for a shoulder belt
- 6 Grip belt
- 7 FOCUS MAGNIFIER button
- 8  (microphone) jack (PLUG IN POWER)
- 9 Remote sensor

- 10 Camera recording lamp
- 11 NIGHT SHOT light
- 12 Multi/Micro USB Terminal
Supports Micro USB compatible devices. If you use an adaptor cable (sold separately), you can also use accessories via an A/V remote connector.

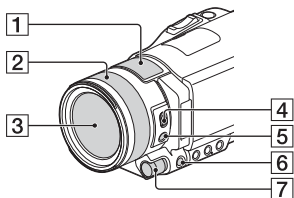

- 1 Built-in microphone
- 2 Lens ring
- 3 Lens (ZEISS lens)
- 4 ZOOM/FOCUS switch
- 5 AF/MF button
- 6 MANUAL button
- 7 MANUAL dial
Manual functions can be assigned to the button and the dial.

Attaching the lens hood (supplied)

Align the red line on the lens hood with the red dot on the lens (hood index), then insert the lens hood into the lens mount and rotate it clockwise until it clicks into place.

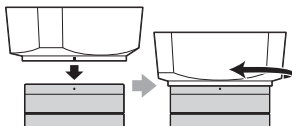

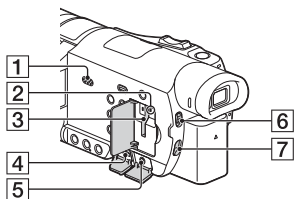

- 1** Speaker
- 2** Memory card access lamp (19)
- 3** Memory card slot (19)
- 4** HDMI OUT jack
- 5** (headphones) jack
- 6** ND FILTER (AUTO/MANUAL) switch
- 7** ND FILTER switch

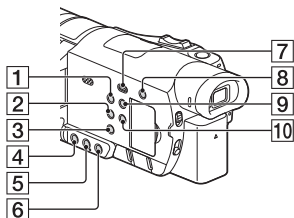

- 1** POWER button
- 2** WHITE BALANCE button
- 3** PROGRAM AE button
- 4** IRIS button
- 5** GAIN/ISO button
- 6** SHUTTER SPEED button
- 7** (View Images) button (28)
- 8** (My Voice Canceling) button
Suppresses the voice of the person recording the movie.
- 9** DISPLAY button

10 NIGHT SHOT button

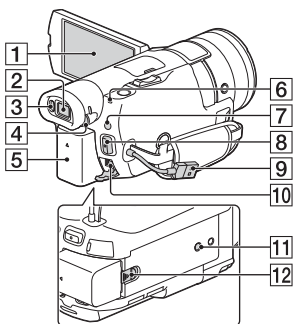

- 1** LCD monitor/Touch panel
- 2** Viewfinder
The camcorder is turned on when the viewfinder is pulled out.
- 3** Eye sensor
When the LCD monitor is closed, pull out the viewfinder and move your eye closer to the viewfinder. You can view the subject through the viewfinder.
- 4** Viewfinder lens adjustment dial
If the indications in the viewfinder appear blurred, turn the viewfinder lens adjustment dial.
- 5** Battery pack (15)
- 6** POWER/CHG (charge) lamp (15)
- 7** (Shooting Mode) button (23)
- 8** START/STOP button (21)
- 9** Built-in USB Cable (15)
- 10** DC IN jack
- 11** Tripod receptacle

12 BATT (battery) release lever

To fasten the grip belt

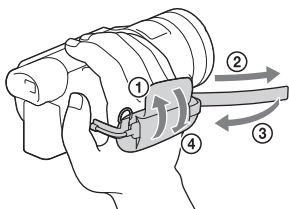

11 PAUSE button

12 VISUAL INDEX button

13 ◀/▶/▲/▼/ENTER buttons

- Remove the insulation sheet before using the Wireless Remote Commander.
- Insulation sheet

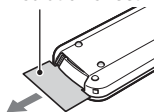

Wireless Remote Commander

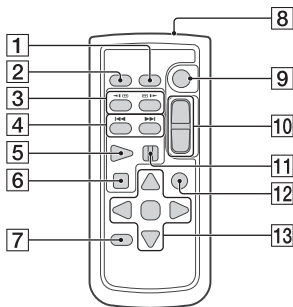

1 DATA CODE button

2 PHOTO button

3 SCAN/SLOW buttons

4 ◀◀/▶▶ (Previous/Next) buttons

5 PLAY button

6 STOP button

7 DISPLAY button

8 Transmitter

9 START/STOP button

10 Power zoom buttons

Index

A

- AC Adaptor 15
- Android 37
- App Store 37
- Assigning a menu item 26
- AVCHD 12, 13

B

- Battery pack 15
- Beep 18
- Built-in USB Cable 15

C

- Charging the battery pack 15
- Charging the battery using your computer 15
- Charging time 16
- Computer 34
- Computer system 34

D

- Date and time 18
- Delete 30
- Dual Video REC 21

E

- Edit 28
- Exposure 26

F

- Focusing manually 27
- Format 20
- Full charge 16

G

- Gain (ISO) 25
- Google play 37
- Grip belt 52

H

- HD 35
- HDMI cable 31

- Help Guide 11

I

- Install 37
- iOS 37
- Iris (aperture) 25

L

- LCD monitor 15

M

- Manual recording 25
- Memory card 19
- Memory Stick PRO Duo (Mark2) media 19
- Memory Stick PRO-HG Duo media 19
- Memory Stick XC-HG Duo media 19
- Menu lists 41
- Menus 41
- Movies 21
- MP4 38
- My Voice Canceling 22

N

- ND filter 27
- Network 32
- NFC 38

O

- One-Touch functions (NFC) 37

P

- Photos 23
- Playback 28
- PlayMemories Home 34
- PlayMemories Online 34
- Power on 18
- Precautions 44

R

- Recording 21
- Recording media 20

Recording time 24
Recording/playback time 16

S

SD memory card 19
Shutter speed 25
Smartphone 37
Software 34
Specifications 46
Supplied items 14

T

Touch panel 23
Tripod 51
Troubleshooting 45
TV 31

U

USB Adaptor Cable 35

W

Wall outlet (wall socket) 16
Wi-Fi 37
Windows 34
Wireless access point 40

X

XAVC S 4K 12, 13
XAVC S HD 12, 13

Z

Zoom 21

Additional information on this product and answers to frequently asked questions can be found at our Customer Support Website.

<http://www.sony.net/>

