

# IC Recorder

## Operating Instructions

### Owner's Record

The model number is located at the rear and the serial number is located inside the battery compartment. Record the serial number in the space provided below. Refer to these numbers whenever you call upon your Sony dealer regarding this product.

Model No. ICD-B5

Serial No. \_\_\_\_\_

## IC RECORDER ICD-B5

Sony Corporation ©2002 Printed in China

http://www.sony.net/

### Information

IN NO EVENT SHALL SELLER BE LIABLE FOR ANY DIRECT, INCIDENTAL OR CONSEQUENTIAL DAMAGES OF ANY NATURE, OR LOSSES OR EXPENSES RESULTING FROM ANY DEFECTIVE PRODUCT OR THE USE OF ANY PRODUCT.

### For the customers in the U.S.A.

#### INFORMATION

This equipment has been tested and found to comply with the limits for a Class B digital device, pursuant to Part 15 of the FCC Rules. These limits are designed to provide reasonable protection against harmful interference in a residential installation. This equipment generates, uses, and can radiate radio frequency energy and, if not installed and used in accordance with the instructions, may cause harmful interference to radio communications.

However, there is no guarantee that interference will not occur in a particular installation. If this equipment does cause harmful interference to radio or television reception, which can be determined by turning the equipment off and on, the user is encouraged to try to correct the interference by one or more of the following measures:

- Reorient or relocate the receiving antenna.
- Increase the separation between the equipment and the receiver.
- Connect the equipment into an outlet on a circuit different from that to which the receiver is connected.
- Consult the dealer or an experienced radio/TV technician for help.

This device complies with Part 15 of the FCC Rules. Operation is subject to the following two conditions: (1) This device may not cause harmful interference, and (2) this device must accept any interference received, including interference that may cause undesired operation.

You are cautioned that any changes or modifications not expressly approved in this manual could void your authority to operate this equipment.

### Precautions

#### On power

- Operate the unit only on 3 V DC. Use two LR03 (size AAA) alkaline batteries.

#### On safety

- Do not operate the unit while driving, cycling or operating any motorized vehicle.

#### On handling

- Do not leave the unit in a location near heat sources, or in a place subject to direct sunlight, excessive dust or mechanical shock.
- Should any solid object or liquid fall into the unit, remove the batteries and have the unit checked by qualified personnel before operating it any further.

#### On noise

- Noise may be heard when the unit is placed near an AC power source, a fluorescent lamp or a mobile phone during recording or playback.
- Noise may be recorded when an object, such as your finger, etc., rubs or scratches the unit during recording.

#### On maintenance

- To clean the exterior, use a soft cloth slightly moistened in water. Do not use alcohol, benzine or thinner.

Keep personal credit cards using magnetic coding or spring-wound watches, etc., away from the unit to prevent possible damage from the magnet used in the speaker.

If you have any questions or problems concerning your unit, please consult your nearest Sony dealer.

#### Backup recommendations

To avoid potential risk of data loss caused by accidental operation or malfunction of the IC recorder, we recommend that you save a backup copy of your recorded messages on a tape recorder, etc.

### ▶Getting started

## Step 1: Installing the Batteries

### 1 Slide and lift the battery compartment lid.

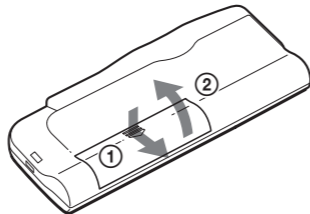

### 2 Insert two LR03 (size AAA) alkaline batteries with correct polarity, and close the lid.

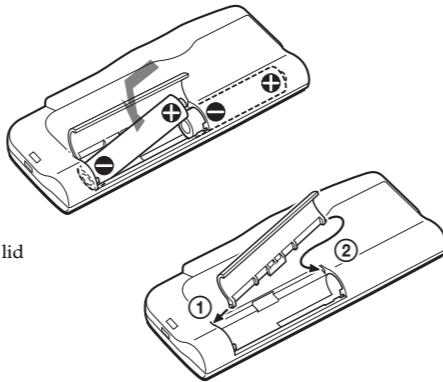

If the battery compartment lid is accidentally detached, attach it as illustrated.

Clock setting display appears when you insert batteries for the first time, or when you insert batteries after the unit has been without batteries for a certain period of time. Please refer to Steps 2 to 3 in "Step 2: Setting the Clock" to set the date and time.

#### Replacing the batteries

The battery indicator on the display window shows the battery condition.

When flashes, replace the batteries with new ones.

When flashes, the batteries are exhausted and the unit will stop operation.

#### Battery life\*

With continuous use, approx. 10 hours recording/8 hours playback is possible.

\* Using Sony alkaline batteries LR03 (size AAA)

\* When playing back through the internal speaker with VOL control at around 4

The battery life may shorten depending on the operation of the unit.

#### Notes

- Do not use manganese batteries for this unit.
- When you replace the batteries, insert the new ones within 3 minutes after you removed the exhausted ones. Otherwise, the display may show the clock setting display or incorrect date and time when you reinsert the batteries. In this case, set the date and time again.
- The recorded messages and alarm setting, however, will remain.
- When replacing the batteries, be sure to replace both batteries with new ones.
- Do not charge dry batteries.
- When you are not going to use the unit for a long time, remove the batteries to prevent damage from battery leakage and corrosion.

### ▶Basic Operations

## Recording Messages

You can record up to 99 messages in each of the two folders (A and B). Since a newly recorded message is automatically added behind the last recorded message, you can start recording quickly without searching for the end of the last recording.

e.g. 

Message 1	Message 2	Newly recorded message	Blank space
-----------	-----------	------------------------	-------------

#### Note

Before making a long recording, be sure to insert new batteries and check the battery indicator.

### 1 Select the folder.

Press FOLDER to display the folder in which you wish to record messages.

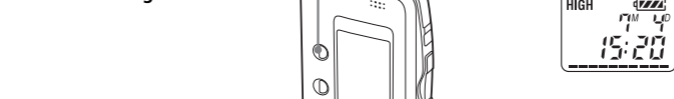

### 2 Start recording.

① Press ●REC/STOP.

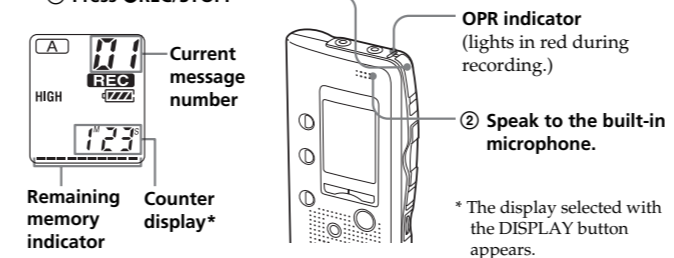

You do not need to keep pressing ●REC/STOP while recording.

### 3 Stop recording.

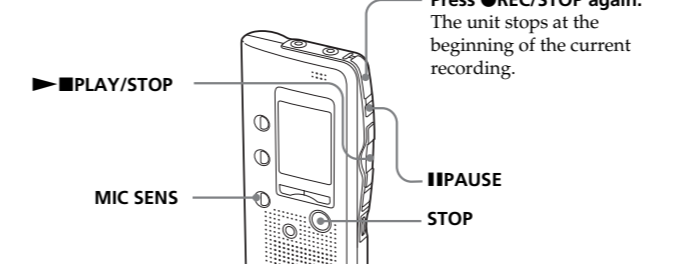

If you do not change the folder after you stop recording, the next time you record you will record in the same folder.

To	Do this
stop recording	Press STOP instead of ●REC/STOP.
pause recording*	Press ■PAUSE. During recording pause, the OPR indicator flashes in red and "PAUSE" flashes in the display window.
release pause and resume recording	Press ■PAUSE or ●REC/STOP. Recording resumes from that point. (To stop recording after pausing recording, press STOP.)
listen to the current recording	Press ●REC/STOP or STOP to stop recording, then press ►PLAY/STOP.
review the current recording instantly	Press ►PLAY/STOP during recording.
select the microphone sensitivity	You can select the microphone sensitivity to display the following by pressing MIC SENS. HIGH: To record at meeting or in a quiet and/or spacious place. LOW: To record for dictation or in a noisy place.

\* About one hour after you pause recording, recording pause is automatically released and the unit goes into the stop mode.

#### Note on recording

Noise may be recorded if an object, such as your finger, etc., accidentally rubs or scratches the unit during recording.

#### Maximum recording time

You can record for up to 150 minutes. You can check the remaining amount of recording time by selecting the remaining recording time display mode.

#### Notes

Due to the limitation of the IC recording system, this unit records in the minimum recording unit of approx. 9 seconds, therefore the following symptoms may occur:

- When a message is shorter than the minimum recording unit, it is still counted as approx. 9 seconds so the remaining recording time will decrease by more than the actual length of the message.
- When the message is longer than the minimum recording unit, the remaining recording time will decrease by more than the actual length of the message if it cannot be divided by the minimum recording unit without a remainder.
- The sum of the number on the counter (elapsed recording time) and the remaining recording time may be less than the unit's maximum recording time (150 minutes).

#### Remaining memory indication

During recording, the remaining memory indicator decreases one by one.

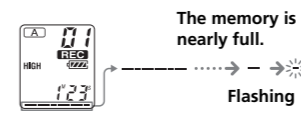

When the remaining time of recording reaches 5 minutes, the last one of the indication flashes.

When the remaining time of recording reaches 1 minute, the selected display mode and "REMAIN" will flash one after the other in the display window. When the memory is full, recording automatically stops and "FULL" will flash in the display window with an alarm sound. To continue recording, first erase some of the messages.

#### Notes

- If you press ●REC/STOP when the memory is full, "FULL" will flash with an alarm sound. Erase some of the messages before you start recording again.
- If you press ●REC/STOP after you have recorded 99 messages, "FULL" will flash with an alarm sound. Select another folder or erase some of the messages.

## Playing Back Messages

When playing back a previously recorded message, start from Step 1. When playing back a message you have just finished recording, start from Step 3.

### 1 Select the folder.

Press FOLDER to display the folder you wish to play back.

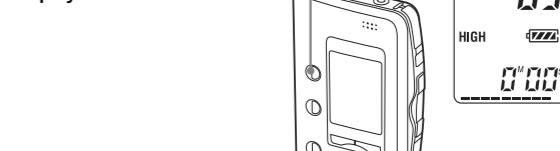

### 2 Select the message number.

Press -◀◀ or ▶▶+ to display the desired message number.

-◀◀: for smaller message number  
▶▶+: for larger message number

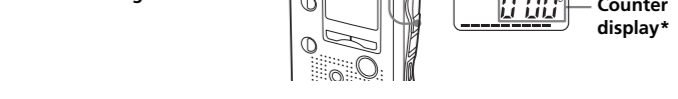

\* The display selected with the DISPLAY button appears (see the reverse side).

### 3 Start playback.

① Press ►PLAY/STOP.

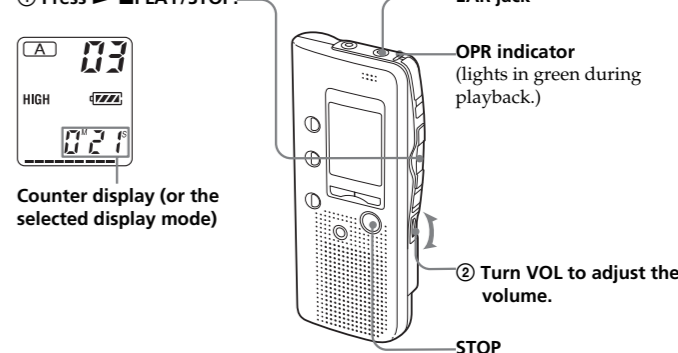

After playing back one message, the unit stops at the beginning of the next message. When the continuous play function is set to "ON" (see the reverse side), the unit stops after playing all messages in a folder.

When the last message on a folder has been played back, the unit stops at the beginning of the last message.

#### For private listening

Connect an earphone or headphones (not supplied) to the EAR jack. The built-in speaker will be automatically disconnected. If you plug in headphones, you will get output from the left channel only. If noise is heard, wipe the headphones plug.

#### Other operations

To	Do this
stop at the beginning of the current message	Press STOP.
stop at the current position (Playback Pause function)*	Press ►PLAY/STOP. To resume playback from that point, press ►PLAY/STOP again.
go back to the beginning of the current message	Press -◀◀ once.
skip to the next message	Press ▶▶+ once.
go back to previous messages/skip to succeeding messages	Press -◀◀ or ▶▶+ repeatedly. (During stop mode, keep the button pressed to skip the messages continuously.)

\* You can also pause playback by pressing ■PAUSE instead of ►PLAY/STOP. The OPR indicator will flash in green. After about one hour, the unit goes into the stop mode at the current position.

#### Playing back a message repeatedly

During playback, press ►PLAY/STOP for more than one second. "C" will be displayed and the selected message will be played back repeatedly.

To resume normal playback, press ►PLAY/STOP again. To stop playback, press STOP.

#### Playing the beginning of each message

During stop mode, press ►PLAY/STOP for more than one second. "SCAN" will be displayed in the display window and the first 5 seconds of each message in the selected folder will be played back. When you find the desired message, press ►PLAY/STOP. The message will be played back until the end.

#### Searching forward/backward during playback (Cue/Review)

To search forward, keep ▶▶+ pressed during playback and release the button at the point you wish to resume playback. To search backward, keep -◀◀ pressed during playback and release the button at the point you wish to resume playback.

If you keep ▶▶+ or -◀◀ pressed for more than 10 seconds, the unit starts to search at higher speed. For the first 10 seconds of cue/review, fast playback sound can be heard. When searching at a higher speed, playback sound will not be heard.

During cue/review, the counter will be displayed, regardless of the display mode setting.

#### Tip

When fast playback is done to the end of the last message, "END" flashes 3 times. (You cannot hear the playback sound.) If you keep -◀◀ pressed while "END" is flashing, the messages are played back rapidly, and normal playback will start at the point you release the button.

When "END" stops flashing and the OPR indicator goes off, the unit will stop at the beginning of the last message. If the last message is long and you wish to start playback at a later part of the message, keep ▶▶+ pressed to play back the message to the end and then press -◀◀ while "END" is flashing to go back to the desired point. (For messages other than the last one, go to the beginning of the next message and play backward to the desired point.)



# Erasing Messages

You can erase the recorded messages one by one or all messages in a folder at a time. Note that once a recording has been erased, you cannot retrieve it.

## Erasing messages one by one

When a message is erased, the remaining messages will advance and renumbered so that there will be no space between messages.

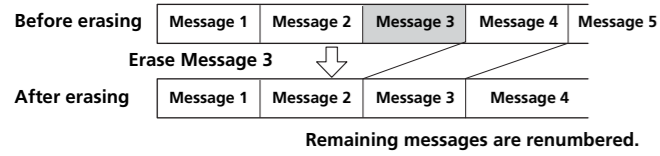

- Press **ERASE** while playing back the message you want to erase or press **ERASE** for more than 1 second during stop mode. A beep will sound and the message number and the "ERASE" will flash while the first and last 5 seconds of the message is played back 10 times.
- Press **ERASE** while the message is being played back. The message is erased and the remaining messages will be renumbered. (For example, if you erase Message 3, Message 4 will be renumbered as Message 3. When erasing is completed, the unit will stop at the beginning of the following message.)

## Erasing all messages in a folder

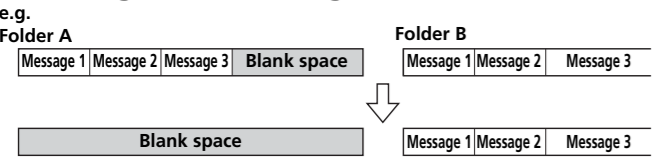

- Press **FOLDER** to select the folder you want to erase.
- While pressing **STOP**, press **ERASE** for more than 1 second. "ALL ERASE" will flash for 10 seconds.
- While the display is flashing, press **ERASE**.

- To cancel erasing**  
Press **STOP** before step ②.
- To erase other messages**  
Repeat steps ① and ②.
- To erase a message partially**  
First divide the message by adding an index and then follow the steps to erase the message.

## To cancel erasing

Press **STOP** before step ②.

## Various Ways of Recording

### Adding a Recording to a Previously Recorded Message

You can add a recording to the message being played back. The added recording will be placed after the current message and counted as a part of the message.

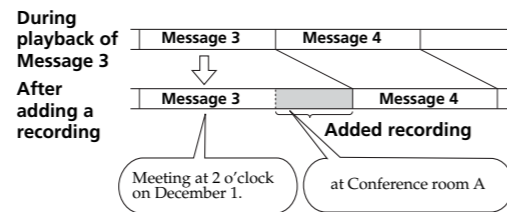

- During playback, press **REC/STOP** for more than 1 second. The REC indicator appears and "PLUS" flashes three times on the display window. The OPR indicator will turn red. The new recording will be added at the end of the current message.

### Recording with an External Microphone or from Other Equipment

- Connect a plug-in-power type microphone or other equipment to the MIC (PLUG IN POWER) jack.

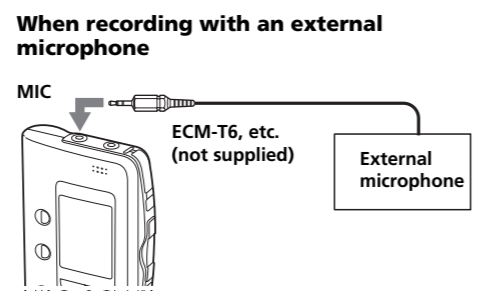

When you connect an external microphone, the built-in microphone is automatically cut off. When a plug in power type microphone is connected, power is automatically supplied to the microphone from the IC recorder.

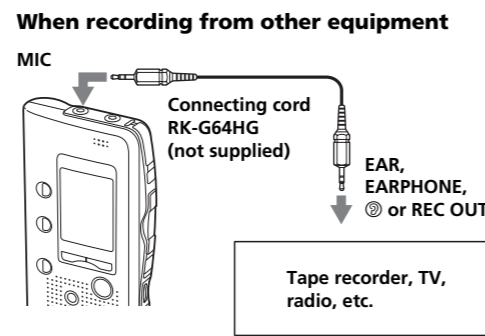

- Follow the steps in "Recording messages" to record messages.

- Notes**
- Make sure that the plugs are connected securely.
  - We recommend you make a trial recording to check the connections and volume control.
  - When connecting equipment other than Sony's, refer to the instruction manual of the equipment.

## Other Functions

### Dividing a Message into Two/Combining Messages — Index Function

You can divide a message by adding an index, or combine messages by erasing the index. While recording/playing back messages, you can add an index (see below). In stop mode, you can erase the index.

#### Dividing a Message by Adding an Index

You can add an index to a message during recording or playback. By dividing a message, you can easily find the point you want to play back when you make a long recording such as a meeting. When you add an index, the message numbers will increase as follows.

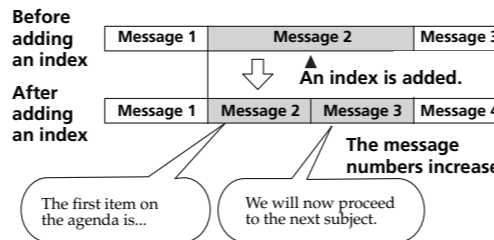

- During playback, press **REC/STOP** for more than 1 second. The REC indicator appears and "PLUS" flashes three times on the display window. The OPR indicator will turn red. The new recording will be added at the end of the current message.
- Press **REC/STOP** or **STOP** to stop the recording.

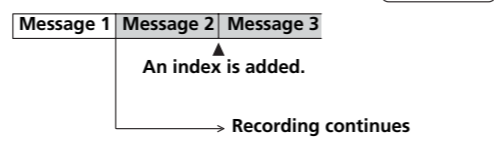

**Tip**  
You can add an index during recording pause.

- To add an index during playback**  
While playing back a message, press **INDEX** at the point you want to divide. The message is divided in two and the new message number flashes three times. An index mark is added and the following index numbers will increase by one.

**Tip**  
You can add an index after you have paused playback with **II PAUSE**.

- To play the message you marked with an index**  
Press **INDEX** or **INDEX** to display the message number as the divided messages each have message numbers.

**To play the divided messages continuously**  
Select "ON" for "CONT" as described in "Playing Back All Messages in a Folder Continuously."

- Notes**
- If 99 messages have been recorded in a folder, you cannot add an index. In that case, reduce the number of messages to 98 or less by erasing unnecessary messages or by moving some of the messages to another folder before adding an index.
  - If you add an index to a message with an alarm setting, the alarm setting remains only with the former message divided.

### Combining Messages by Erasing the Index

You can combine two messages into one by erasing the index.

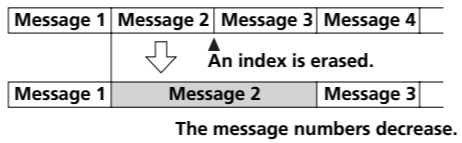

In stop mode, follow the steps below:

- Press **INDEX** or **INDEX** to display the number of the second of the two messages you want to combine.
- While pressing **ERASE**, press **INDEX** for more than 1 second. "ID ERASE" will flash for 10 seconds.
- Press **ERASE** while the display is flashing. The two messages are combined into one and the messages will be renumbered as in the illustration above.

- To cancel erasing**  
Press **STOP** before step 3.

- Notes on adding/erasing index**  
When recording with an IC recorder, the following symptoms may occur because of the limitation of the system, however, they are not malfunction.
- If you add/erase indexes frequently, the unit may become unable to add/erase indexes.
  - You cannot add an index in the first or the last 1 second.
  - After combining messages by erasing an index, the latter message's alarm setting will be erased.

## Moving Messages to a Different Folder — Move Function

You can move the recorded messages to another folder.

Example: Moving Message 3 in Folder A to Folder B

- Play back the message you want to move.
- While playing back the message, press **FOLDER** to flash the indication of the folder to which you want to move the message (B in this case). The first and last 5 seconds of the message will be played back 10 times, while the folder indication and "MOVE" flash.
- Press **PLAY/STOP**. The message is moved in the destination folder. Messages are sorted in order of the recorded date and time.

- To cancel moving the message(s)**  
Press **STOP** before step 3.

**Note**  
The move function does not duplicate a message in another folder. When you move a message to another folder, the one in the previous folder will be deleted.

## Playing Back a Message at a Desired Time with an Alarm

You can sound an alarm and start playback of a selected message at a desired time.

- Use **FOLDER** and **INDEX** to select the folder and the message you want to play back.
- Enter the alarm setting mode.

- Press **MENU**. The unit enters the menu mode and "ALARM OFF" will be displayed. (If "ALARM ON" is displayed, the alarm has been set. If you do not wish to change the setting, press **MENU** and exit the menu mode.)

**Note**  
"ALARM OFF (or ON)" will not appear and the alarm cannot be set if the clock has not been set or no message has been recorded in the selected folder.

- Press **PLAY/STOP**. "OFF" starts to flash.

- Press **INDEX** or **INDEX** to flash "ON".

- Press **PLAY/STOP**. "DATE" will flash in the display window.

- Set the alarm date.

**To play back on a desired date**  
(the message will be played back at the same time on the same date every year until you erase the message)

- Press **PLAY/STOP** while "DATE" is flashing. The month digits will flash.

- Press **INDEX** or **INDEX** to select the month digits and press **PLAY/STOP**. The day digits will flash.

- Press **INDEX** or **INDEX** to select the day digits.

- Press **PLAY/STOP** once a week. Press **INDEX** or **INDEX** to select the day of the week.

- Press **PLAY/STOP** at the same time every day. Press **INDEX** or **INDEX** to select "DAILY".

- Press **PLAY/STOP**. The hour digits will flash.

- Set the alarm time.

- Press **INDEX** or **INDEX** to select the hour digits and press **PLAY/STOP**. The minute digits will flash.

- Press **INDEX** or **INDEX** to select the minute digits and press **PLAY/STOP**. "ALARM ON" and "ON" will be displayed to indicate that the setting has been completed.

- Press **MENU** to exit the menu mode.

"ON" is displayed when the number of the message with alarm setting is selected.

At the set time, the alarm will sound for about 10 seconds and the selected message will be played back.

During playback, "ALARM" will flash in the display window.

When the playback ends, the unit will stop automatically at the beginning of that message.

**To listen to the same message again**  
Press **PLAY/STOP**. The same message will be played back from the beginning.

**To cancel the alarm setting before the playback starts**  
Press **STOP** while the alarm sound is heard. You can stop even when the HOLD function is activated.

**Notes**

- You cannot set the alarm if you have not set the clock or there is no message in the selected folder (the unit will not enter the alarm setting mode when you press **MENU** in Step 2).
- If you try to set the alarm to play back a message at a previously set time on another message, "PRE SET" will be displayed, preventing new settings.
- If the alarm time comes while another message is being played back with an alarm, the playback stops and the new message will be played back.
- If the alarm time comes during recording, alarm will sound for 10 seconds after the recording is finished and playback begins. "ON" will flash when the alarm time comes.
- If more than one alarm time comes during recording, only the first message will be played back.
- When the alarm time comes when the unit is in the menu mode, alarm will sound and the menu mode will be cancelled.
- If you erase the message you set the alarm to play back, the alarm setting will be cancelled.
- If you add an index to the message you set the alarm to play back, playback will stop at the index.
- If you erase the index on the message you set the alarm to play back, the alarm setting will be cancelled.
- You can adjust the playback volume with the VOL control.
- If the alarm time comes during erasing, alarm will sound for 10 seconds after the erasing is finished and playback begins.
- Alarm setting will not be cancelled when the alarm playback finishes. To cancel alarm setting, see below.

**To cancel the alarm setting or change the alarm time**

- Select the message you set the alarm to play back, and press **MENU**.

- Press **PLAY/STOP** to flash "ON".

- To cancel the alarm setting: Press **INDEX** or **INDEX** to flash "OFF" and press **PLAY/STOP**.

**To change the alarm date and time:** Press **PLAY/STOP**. When the alarm date is displayed, follow the steps 3 to 5 above to change the alarm date and time.

- Press **MENU** to exit the menu mode.

**What beep sound means**

Beep patterns	Meaning
- (single tone)	Usual mode
- (double tone)	Enter/exit special mode
--- (triple tone)	Notice*
----	(forth tone) Lack of battery power.
----- (continuous beep)	Alarm set time has come.

\* This pattern lets you know the procedure is wrong or informs you of some messages, such as:

- you are trying to record a message when you have already recorded up to the maximum recordable time or the maximum number of messages.
- you reaches at the top of the first message or end of the last message in a folder.

**Preventing Accidental Operation — HOLD function**

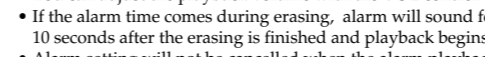

Slide the HOLD switch in the direction of the arrow. "HOLD" will flash three times, indicating that all the functions of the buttons are locked.

To cancel the HOLD function, simply slide the HOLD switch in the opposite direction.

**Note**  
When the HOLD function is activated during recording, cancel the HOLD function first to stop recording.

**Tip**  
Even if the HOLD function is activated, you can stop the alarm playback. To stop the alarm or playback, press **STOP**.

## Selecting the Display Mode

You can select the display mode for the stop, recording and playback modes. (If the unit is left unoperated for more than 3 seconds in the stop mode, the display will show the current time, regardless of the display mode setting.) Each time you press **DISPLAY**, the display mode will change as shown below:

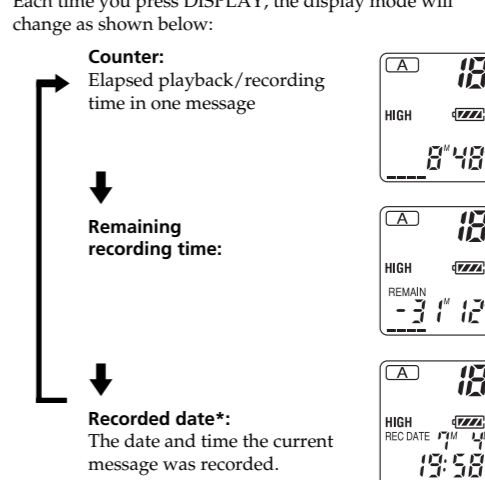

\* If the clock has not been set, "M-D ----" will be displayed.

## Turning off the Beep Sound

**BEEP ON:** A beep will sound to indicate that operation has been accepted.

**BEEP OFF:** No beep sound will be heard except for the alarm and timer.

- Press **MENU** to enter the menu mode.

- Press **INDEX** or **INDEX** to display "BEEP ON (or OFF)" and press **PLAY/STOP**. "ON (or OFF)" will flash.

- Press **INDEX** or **INDEX** to select "ON" or "OFF" and press **PLAY/STOP**. The setting is completed.

- Press **MENU** to exit the menu mode.

## Playing Back All Messages in a Folder Continuously

**CONT ON:** You can play back all messages in a folder continuously.

**CONT OFF:** Playback stops at the end of each message.

- Press **MENU** to enter the menu mode.
- Press **INDEX** or **INDEX** to display "CONT" or "OFF" and press **PLAY/STOP**. "OFF (or ON)" will flash.
- Press **INDEX** or **INDEX** to select "ON" or "OFF" and press **PLAY/STOP**. Now the setting is completed.
- Press **MENU** to exit the menu mode.

## Specifications

Recording media: Built-in flash memory, Monaural recording

Recording time: 150 minutes

Frequency response: 150 Hz - 3,500 Hz

Speaker: approx. 3.2 cm (1 5/16 in.) dia.

Power output: 150 mW

Input/Output: Earphone jack (minijack) for 8 - 300 ohms earphone/headphones

Microphone jack (minijack, monaural)

Plug in power Minimum input level 0.6 mV

3 kilohms or lower impedance microphone

Two LR03 (size AAA) alkaline batteries: 3 V DC

44.5 × 105.3 × 14.0 mm (1 13/16 × 4 1/4 × 9/16 in.)

Mass (incl. batteries): 68 g (2.4 oz)

Optional accessories: Electret Condenser Microphone ECM-T6, ECM-Z60, Connecting cord RK-G64HG

Your dealer may not handle some of the above listed optional accessories. Please ask the dealer for detailed information.

Design and specifications are subject to change without notice.

# Index to Parts and Controls

## Main unit

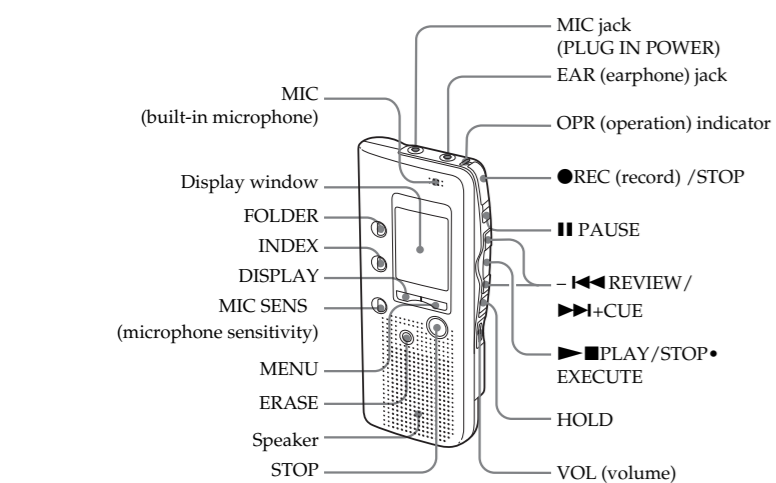

## Rear

