

SONY®

2-696-114-61(1)

Wireless Stereo Headset

Operating Instructions



DR-BT30Q

©2006 Sony Corporation

WARNING

To reduce the risk of fire or electric shock, do not expose this apparatus to rain or moisture.

To reduce the risk of electrical shock, do not open the cabinet. Refer servicing to qualified personnel only.

Do not install the appliance in a confined space, such as a bookcase or built-in cabinet.

To reduce the risk of fire, do not cover the ventilation of the apparatus with newspapers, tablecloths, curtains, etc. And do not place lighted candles on the apparatus.

To reduce the risk of fire or electric shock, do not place objects filled with liquids, such as vases, on the apparatus.

Connect the AC power adaptor to an easily accessible AC outlet. Should you notice an abnormality in the AC power adaptor, disconnect it from the AC outlet immediately.

The Bluetooth word mark and logos are owned by the Bluetooth SIG, Inc. and any use of such marks by Sony Corporation is under license.

Other trademarks and trade names are those of their respective owners.

MPEG Layer-3 audio coding technology and patents licensed from Fraunhofer IIS and Thomson.

Table Of Contents

Welcome!	4
3 steps to BLUETOOTH function	5
Location and Function of Parts	6
Charging the unit	7
Pairing	9
What is pairing?	9
Procedures of pairing	9
Wearing the headset	11
Indications of BLUETOOTH function	12
Listening to music	13
Controlling the audio device – AVRCP	14
Calling	16
Controlling the BLUETOOTH mobile phone – HFP, HSP ..	18
Calling while playing back music	19
Disposing of the unit	20
Precautions	21
What is BLUETOOTH technology?	23
Troubleshooting	24
Initializing the unit	25
Specifications	26

Welcome!

Thank you for purchasing this Sony Wireless Stereo Headset. This unit uses BLUETOOTH™ wireless technology.

- You can enjoy music from your BLUETOOTH device capable of transmitting music.
- You can enjoy hands-free talking with your BLUETOOTH mobile phone inside your bag.
- You can remotely control the basic functions of BLUETOOTH audio device (Play, Pause, Stop, etc.).
- You can charge the unit using the supplied AC power adaptor.
- By simply pressing the button, the cord of the unit is retracted for storage.

For details on BLUETOOTH technology, see page 23.



3 steps to BLUETOOTH function

Pairing

First, register (“pair”) a BLUETOOTH device (mobile phone, etc.) and this unit with each other. Once pairing is established, there is no need for pairing again.

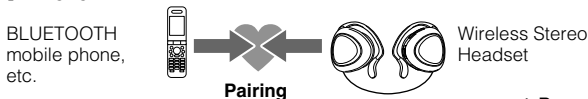

Listening to music

BLUETOOTH connection

Operate the BLUETOOTH device to make the BLUETOOTH connection.

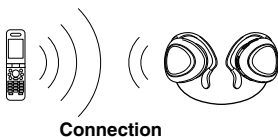

A2DP

AVRCP

→ Page 13

Calling

BLUETOOTH connection

When the unit is turned on, the unit starts making the BLUETOOTH connection to the recognized mobile phone automatically.



Connection

HFP

HSP

→ Page 16

Listening to music

You can listen to music played on the BLUETOOTH device. Playback, stop, or pause is possible from this unit.



→ Page 13 - 15

Talking on the phone

You can make and receive a call by operating this unit.

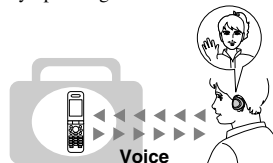

→ Page 17 - 19

Location and Function of Parts

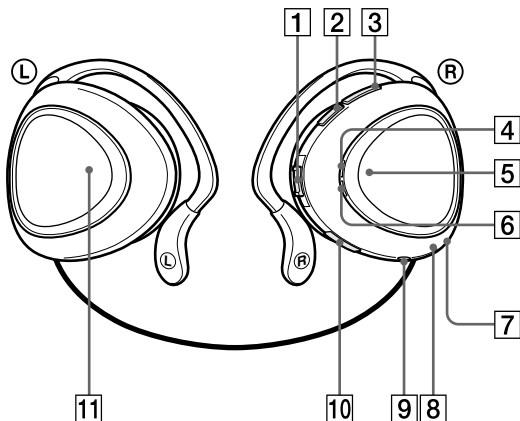

1 Jog switch

Controls various functions when listening to music.

2 VOLUME – button

3 VOLUME + button

4 Indicator (blue)

Indicates the communication status of the unit.

5 Multi function button

Controls various call functions.

6 Indicator (red)

Indicates the power status of the unit.

7 Microphone

8 RESET button

Press when the unit becomes inoperative.

Pairing information is not deleted by this operation.

9 DC IN 3 V jack

10 POWER button

11 AUTO WIND button

Retracts the cord of the unit.

Charging the unit

The unit contains a rechargeable Lithium-Ion battery, which should be charged before using for the first time.

1 Connect the supplied AC power adaptor to the DC IN 3 V jack on the unit.

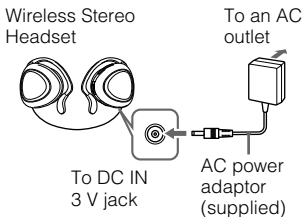

When the AC power adaptor is connected to an AC outlet, charging starts.

Tip

If the AC power adaptor is connected to an AC outlet while the unit is turned on, the unit will be turned off automatically.

2 Make sure that indicator (red) lights up while charging.

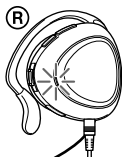

Charging is completed in about 3 hours* and the indicator (red) goes off automatically.

* Time required for empty battery to recharge.

Caution

If this unit detects a problem while charging, the indicator (red) may turn off, although charging is not complete.

Check for the following causes:

- Ambient temperature exceeds the range of 0 °C – 40 °C (32 °F – 104 °F).
- There is a problem with the battery.

In this case, charge again within the above-mentioned temperature range. If the problem persists, consult your nearest Sony dealer.

Notes

- If the battery is not used for a long time, battery may be quickly depleted, however, after a few recharges, battery life will improve.
- If the life of the built-in rechargeable battery drops to half the normal length, the battery should be replaced. Consult your nearest Sony dealer for replacement of the rechargeable battery.
- Avoid exposure to temperature extremes, direct sunlight, moisture, sand, dust or mechanical shock. Never leave in a car parked in the sun.
- Use only the supplied AC power adaptor. Do not use any other AC power adaptor.

Usage hours*

Status	Approx. usage hours
Communication time (including music playback time) (up to)	11 hours
Standby time (up to)	100 hours

* Time stated above may vary, depending on ambient temperature or conditions of use.

Checking the remaining battery

When pressing the POWER button while the unit is turned on, the indicator (red) flashes. You can check the remaining battery by the number of times the indicator (red) flashes.

Indicator (red)	Status
3 times	Full
2 times	Mid
1 time	Low (needs to charge)

Note

You cannot check the remaining battery immediately after the unit is turned on, or during the procedure for pairing.

When the battery is almost empty

The indicator (red) flashes slowly automatically.

When the battery becomes empty, a beep sounds and the unit will turn off automatically.

Pairing

What is pairing?

BLUETOOTH devices need to be “paired” with each other beforehand. Once BLUETOOTH devices are paired, there is no need for pairing again, except in the following cases:

- Pairing information is deleted after repair, etc.
- This unit is paired with 9 or more devices.

This unit can be paired with up to 8 devices; if a new device is paired after 8 devices have been paired, the device whose latest connection time is the oldest among the 8 paired devices is replaced by the new one.

- When recognition of the unit by the device to be connected is deleted.
- This unit is initialized. All pairing information is deleted.

Procedures of pairing

- 1 Place the connecting device within 1 m (3 ft) of this unit.**
- 2 Press and hold the POWER button for 7 seconds or more to standby for pairing while the unit is turned off.**

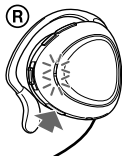

Notes

- After about 3 seconds, power is turned on and the indicator (blue) and indicator (red) flash together twice. Keep the button pressed without releasing until both indicators start flashing together, then release the button. This unit enters into pairing mode.
- If pairing is not established within about 5 minutes, pairing mode will be cancelled and this unit will turn off. In this case, start over from step **1**.

3 Perform pairing procedure on the connecting device to detect this unit.

The list of detected devices appears on the display of the connecting device. This unit is displayed as “DR-BT30Q.”

If “DR-BT30Q” is not displayed, repeat from step **1**.

4 Select “DR-BT30Q” on the display of the connecting device.

5 If Passcode* input is required on the display of a connecting device, input “0000.”

Pairing is complete when the indicator (blue) flashes slowly. The message standing for “Pairing complete” appears on the display of some BLUETOOTH devices.

* Passcode may be called “Passkey,” “PIN code,” “PIN number,” or “Password.”

6 Start the BLUETOOTH connection from the BLUETOOTH device.

This unit memorizes the device as the latest connected device. Some BLUETOOTH devices may connect with the unit automatically when pairing is complete.

When pairing with a BLUETOOTH device that cannot display a list of detected devices or that has no display

You may pair the device by setting both this unit and the connecting device to pairing mode. For details, refer to the operating instructions supplied with the connecting device.

Tips

- To pair with other BLUETOOTH devices, repeat steps **1** to **5** for each device.
- To delete all pairing information, see “Initializing the unit” (page 25).

Wearing the headset

1 Pull out the cord.

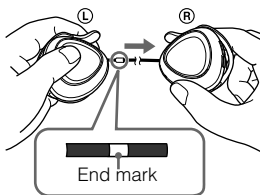

Note

Do not pull out the cord forcibly beyond the end mark.

2 Hook the upper section around the top of your left ear and ensure that it is seated snugly around the back of your ear.

Wear the housing marked **(R)** in your right ear and the one marked **(L)** in your left ear.



Retracting the cord

Remove the housings from your ears, hold the cord, and press the AUTO WIND button to retract the cord as shown by the arrow in the illustration closing the headset upper sections.

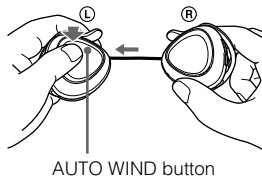

Note

If the cord is stopped midway, pull out the cord about 50 cm (1.6 ft) and press the AUTO WIND button again.

Indications of BLUETOOTH function

B : Indicator (blue)

R : Indicator (red)

Status		Flashing patterns	
Pairing	Searching	B	● - ● - ● - ● - ● - ● - ● - ● - ...
		R	● - ● - ● - ● - ● - ● - ● - ● - ...
Connecting	Connectable	B	● - - - ● - - - ● - - - ● - - - ● ...
		R	-
	Connecting	B	● - - - ● - - - ● - - - ● - - - ● ...
		R	● - - - ● - - - ● - - - ● - - - ● ...
Connected	HFP/HSP or A2DP (standby for receiving audio signal)	B	● - - - - - - - - - ● - - - - - ...
		R	-
	HFP/HSP and A2DP (standby for receiving audio signal)	B	● - ● - - - - - - - - ● - ● - - - ...
		R	-
Music	Listening	B	●● - - - - - - - - - ●● - - - - ...
		R	-
	Listening during standby for telephone call	B	●●● - - - - - - - - - ●●● - - - ...
		R	-
Phone	Incoming call	B	●●●●●● ...
		R	-
	Talking	B	●● - - - - - - - - - ●● - - - ...
	R	-	
	Calling while playing back music	B	●●● - - - - - - - - - ●●● - - - ...
		R	-

Listening to music

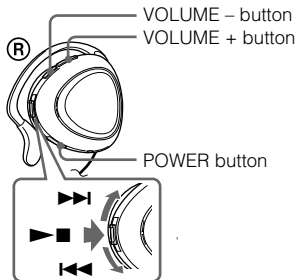

Check the following before operating the unit.

- The BLUETOOTH device is turned on.
- Pairing of this unit and the BLUETOOTH device is complete.
- The BLUETOOTH device supports the transmitting music function (profile: A2DP).

1 Press and hold the **POWER** button for about 3 seconds while the unit is turned off.

The indicator (blue) and indicator (red) flash together twice and the unit is turned on.

Note

Do not press and hold the POWER button for more than 7 seconds, otherwise pairing mode is entered.

2 Make the BLUETOOTH connection (A2DP) from a BLUETOOTH device to this unit.

Refer to the operating instructions supplied with the BLUETOOTH device on how to operate it.

3 Start playback on the BLUETOOTH device.

Tip

BLUETOOTH connection of A2DP (Advanced Audio Distribution Profile) can also be operated with the jog switch from this unit to the BLUETOOTH device except when making a call on this unit.

Note

When you play music by connecting the unit to a BLUETOOTH device using HSP (Headset Profile)*, sound quality will not be high. For better sound, change the BLUETOOTH connection to A2DP* by operating the BLUETOOTH device.

* For detail on profiles, see page 23.

To adjust the volume

Press the VOLUME + or – button while listening to the music.

Tips

- Depending on the connected device, it may be necessary to adjust the volume on the connected device as well.
- Volume level for calling and listening to music can be set independently.

To stop use

1 Terminate the BLUETOOTH connection by operating the BLUETOOTH device.

2 Press and hold the POWER button for about 3 seconds.

The indicator (blue) and indicator (red) light up together, and the unit turns off.

Tip

When you finish playing music, the BLUETOOTH connection may terminate automatically, depending on the BLUETOOTH device.

Controlling the audio device – AVRCP

If the BLUETOOTH audio device connected with this unit supports AVRCP (Audio Video Remote Control Profile), you can control by using the unit buttons. Refer to the operating instructions supplied with the connecting device on how to operate it.

Note

Operation of the BLUETOOTH connecting device by this unit will vary depending on its specification.

Status: In stop or pause mode

	Press	
	once	and hold
▶■	①	②
◀◀/▶▶	③	④

- ① Starts playback*1
- ② Stop
- ③ Skip to next/previous
- ④ Fast-forward/Fast-rewind*2

Status: In play mode

	Press	
	once	and hold
▶■	⑤	⑥
◀◀/▶▶	⑦	⑧

- ⑤ Pause*1
- ⑥ Stop
- ⑦ Skip to next/previous
- ⑧ Fast-forward/Fast-rewind*2

*1 You may need to press the button twice depending on the BLUETOOTH device.

*2 Some BLUETOOTH devices may not operate.

Note

You cannot adjust the volume of the BLUETOOTH device by the unit volume buttons.

Calling

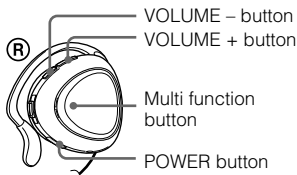

Check the following before operating the unit.

- The BLUETOOTH function is active on the mobile phone.
- Pairing of this unit and the BLUETOOTH mobile phone is complete.

1 Press and hold the **POWER** button for about 3 seconds while the unit is turned off.

The indicator (blue) and indicator (red) flash together twice, the unit turns on and then this unit automatically connects to the last BLUETOOTH mobile phone that was used.

Note

Do not press and hold the POWER button for more than 7 seconds, otherwise pairing mode is entered.

Tip

This unit will stop trying to connect to the BLUETOOTH mobile phone after 1 minute. In such a case, press the multi function button to try to connect again.

When you want to connect the unit to a different BLUETOOTH mobile phone from the last time, follow the procedure in “When this unit does not connect to a BLUETOOTH mobile phone automatically.”

When this unit does not connect to a BLUETOOTH mobile phone automatically

1 Make the BLUETOOTH connection (HFP or HSP) from the BLUETOOTH mobile phone to this unit.

Refer to the manual supplied with your BLUETOOTH mobile phone for operation details. The list of recognized devices appears on the display of the BLUETOOTH mobile phone. This unit is displayed as “DR-BT30Q.”

When you use the BLUETOOTH mobile phone features both HFP (Hands-free Profile) and HSP (Headset Profile)*, set to HFP.

* For details on profiles, see page 23.

Note

When listening to music by operating this unit connected to a BLUETOOTH mobile phone, make the BLUETOOTH connection by operating the BLUETOOTH mobile phone. This cannot be done with the multi function button.

To call

1 Use the buttons on your mobile phone when making a call.

If no sound is heard through this unit, press the multi function button.

Tip

You can call in the following way, depending on the BLUETOOTH mobile phone. Refer to the manual supplied with your mobile phone on operating details.

- When not communicating, you can call using the voice-dial function by pressing the multi function button.
- You can call the last dialed number by pressing the multi function button for about 2 seconds.

To receive a call

When the telephone is ringing, ring tone will be heard through the unit.

1 Press the multi function button on the unit.

The ring tone differs in the following ways, depending on your mobile phone.

- ring tone set on the unit
- ring tone set on the mobile phone
- ring tone set on the mobile phone only for BLUETOOTH connection

Note

If you pressed the call button on the BLUETOOTH mobile phone, some BLUETOOTH mobile phones may have handset use priority. In this case, set to talk with the unit by pressing and holding the multi function button for about 2 seconds, or by operating the BLUETOOTH mobile phone. For details, refer to the manual supplied with your BLUETOOTH mobile phone.

To adjust the volume

Press the VOLUME + or – button.

Tips

- You cannot adjust the volume when not communicating.
- Volume level for calling and listening to music can be set independently.

To terminate a call

You can end a call by pressing the multi function button on the unit.

To stop use

1 Terminate BLUETOOTH connection by the BLUETOOTH mobile phone.

2 Press and hold the POWER button for about 3 seconds to turn off the power.

The indicator (blue) and indicator (red) light up together, and the unit turns off.

Controlling the BLUETOOTH mobile phone – HFP, HSP

The operation of the buttons on this unit varies depending on your mobile phone.

HFP (Hands-free Profile) or HSP (Headset Profile) is used for BLUETOOTH mobile phone. Refer to the operating instructions supplied with your BLUETOOTH mobile phone on supported BLUETOOTH profiles or how to operate.

- *1 Some functions may not be supported depending on the BLUETOOTH mobile phone.
- *2 This may vary, depending on the BLUETOOTH mobile phone.
- *3 Some functions may not be supported when calling using the BLUETOOTH mobile phone.

HFP (Hands-free Profile)

Status	Multi function button	
	Short Press	Long Press
Standby	Start Voice Dial	Last number redial
Voice Dial active	Cancel Voice Dial	–
Outgoing call	End outgoing call	–
Incoming call	Answer	Reject
During call	End call	Change active device

HSP (Headset Profile)

Status	Multi function button	
	Short Press	Long Press
Standby	–	Dial*1
Outgoing call	End outgoing call*1	End outgoing call or change active device to headset*2
Incoming call	Answer	–
During call	End call*3	Change active device to headset

Calling while playing back music

If the BLUETOOTH connection is active with the mobile phone, you can switch the unit to call even when listening to music.

Before starting, see “Calling” (page 16) on operating details.

To call while playing back music

- 1 Press the multi function button while playing back music (page 16), or operate your BLUETOOTH mobile phone to make a telephone call.**

If no sound is heard through this unit, press and hold the multi function button for about 2 seconds.

To receive a call while playing back music

Music is paused and a ring tone is heard through this unit.

- 1 Press the multi function button and talk.**

After finishing the call, press the multi function button. This unit is switched back to music playback.

If music is not paused and a ring tone is not heard through this unit

- 1 Stop music playback.**
- 2 When ringing, press the multi function button and talk.**

Disposing of the unit

For environmental conservation, be sure to remove the built-in rechargeable batteries from the unit before disposing, and dispose of the batteries appropriately.

- 1 Remove the screw on the right housing using a cross-point screwdriver.**

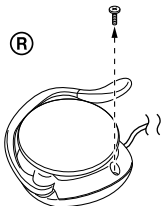

- 2 Put your finger beside the POWER button, and detach the cover by unhooking the claws.**

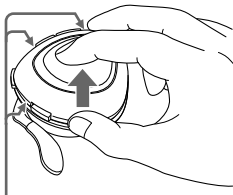

Claws (inside housing)

If the opening is narrow, use a flat screwdriver to unhook the claws.

- 3 Unhook the claws on both sides of the jog switch to detach the board, and hold up the board by the jog switch.**

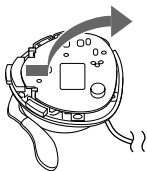

Note

While holding up the board, be careful not to break any wires inside.

- 4 Detach the battery connector, and remove the battery by prizing up the tab.**

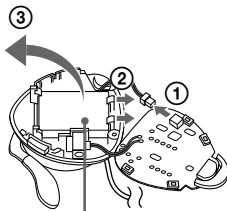

Battery

Precautions

On BLUETOOTH communication

- BLUETOOTH wireless technology operates within a range of about 10 meters (about 30 feet). Maximum communication range may vary depending on obstacles (person, metal, wall, etc.) or electromagnetic environment.
- The antenna of this unit is built into the housing for the right ear. The sensitivity of BLUETOOTH communication will improve by placing a connected BLUETOOTH device on your right side.
- The following conditions may affect the sensitivity of BLUETOOTH communication.
 - There is an obstacle such as a person, metal, or wall between this unit and BLUETOOTH device.
 - A device using 2.4 GHz frequency, such as a wireless LAN device, cordless telephone, or microwave oven, is in use near this unit.
- Because BLUETOOTH devices and wireless LAN (IEEE802.11b/g) use the same frequency, microwave interference may occur and resulting in communication speed deterioration, noise, or invalid connection if this unit is used near a wireless LAN device. In such as case, perform the following.
 - Use this unit at least 10 m (about 30 ft) away from the wireless LAN device.
 - If this unit is used within 10 m (about 30 ft) of a wireless LAN device, turn off the wireless LAN device.
 - Install this unit and BLUETOOTH device as near to each other as possible.
- Microwaves emitting from a BLUETOOTH device may affect the operation of electronic medical devices. Turn off this unit and other BLUETOOTH devices in the following locations, as it may cause an accident.
 - where inflammable gas is present, in a hospital, train, airplane, or a petrol station
 - near automatic doors or a fire alarm
- This unit supports security capabilities that comply with the BLUETOOTH standard to provide a secure connection when the BLUETOOTH wireless technology is used, but security may not be enough depending on the setting. Be careful when communicating using BLUETOOTH wireless technology.
- We do not take any responsibility for the leakage of information during BLUETOOTH communication.
- Connection with all BLUETOOTH devices cannot be guaranteed.
 - A device featuring BLUETOOTH function is required to conform to the BLUETOOTH standard specified by BLUETOOTH SIG, and be authenticated.
 - Even if the connected device conforms to the above mentioned BLUETOOTH standard, some devices may not be connected or work correctly, depending on the features or specifications of the device.
 - While talking on the phone hands free, noise may occur, depending on the device or communication environment.
- Depending on the device to be connected, it may require some time to start communication.

On the supplied AC power adaptor

- Use the AC power adaptor supplied with this unit. Do not use any other AC power adaptor since it may cause the unit to malfunction.



Polarity of the plug

- If you are not going to use this unit for a long time, unplug the AC power adaptor from the AC outlet. To remove the AC power adaptor from the wall outlet, grasp the adaptor plug itself; never pull the cord.

Others

- Do not place this unit in a place exposed to humidity, dust, soot or steam, subject to direct sunlight, or in a car waiting at a traffic signal. It may cause a malfunction.
- Using the BLUETOOTH device may not function on mobile phones, depending on radio wave conditions and location where the equipment is being used.
- If you experience discomfort after using the BLUETOOTH device, stop using the BLUETOOTH device immediately. Should any problem persist, consult your nearest Sony dealer.
- Listening with this unit at high volume may affect your hearing. For traffic safety, do not use this unit while driving or cycling.
- Do not put weight or pressure on this unit as it may cause the unit to deform during long storage.
- If you have any questions or problems concerning this unit that are not covered in this manual, please consult your nearest Sony dealer.

What is BLUETOOTH technology?

BLUETOOTH wireless technology is a short-range wireless technology that enables wireless data communication between digital devices, such as a computer or digital camera. BLUETOOTH wireless technology operates within a range of about 10 meters (about 30 feet).

Connecting two devices as necessary is common, but some devices can be connected to multiple devices at the same time. You do not need to use a cable for connection since BLUETOOTH technology is a wireless technology, nor is it necessary for the devices to face one another, such is the case with infrared technology. For example, you can use such a device in a bag or pocket. BLUETOOTH technology is an international standard supported by thousands of companies all over the world, and employed by various companies worldwide.

Communication System and Compatible BLUETOOTH Profiles of this unit

Profile is standardization of the function for each BLUETOOTH device specification. This unit supports the following BLUETOOTH version and profiles:

Communication System :

BLUETOOTH Specification version 2.0

Compatible BLUETOOTH Profiles:

- A2DP (Advanced Audio Distribution Profile): Transmitting or receiving audio content of high-quality.
- AVRCP (Audio Video Remote Control Profile): Controlling A/V equipment; pausing, stopping, starting playback, volume control, etc.
- HSP (Headset Profile)*: Talking on the phone/Operating the phone.
- HFP (Hands-free Profile)*: Talking on the phone/Operating the phone by hands-free.

* When you use a BLUETOOTH mobile phone supported by both HFP (Hands-free Profile) and HSP (Headset Profile), set to HFP.

Note

To be able to use the BLUETOOTH function, the BLUETOOTH device to be connected requires the same profile as the unit's.

Note also that even if the same profile exists, devices may vary in function depending on their specifications.

Troubleshooting

If you run into any problems using this unit, use the following checklist. Should any problem persist, consult your nearest Sony dealer.

Common

The unit is not turned on.

- ➔ Charge the battery of the unit.
- ➔ The unit is not turned on while charging. Unplug the unit from AC power adaptor and then turn on the unit.

Pairing cannot be done.

- ➔ Bring this unit and the BLUETOOTH device closer together.

Cannot make the BLUETOOTH connection.

- ➔ Check that this unit is turned on.
- ➔ Check that the BLUETOOTH connecting device is turned on and the BLUETOOTH function is on.
- ➔ Connection with the BLUETOOTH device may not be memorized on this unit. Make the BLUETOOTH connection from the BLUETOOTH device to this unit soon after pairing is complete.
- ➔ This unit or BLUETOOTH connecting device is in sleep mode.
- ➔ The BLUETOOTH connection is terminated. Make the BLUETOOTH connection again.

Distorted sound

- ➔ Ensure that this unit is not receiving interference from a wireless LAN, other 2.4 GHz wireless device, or microwave oven.
- ➔ Re-position this unit.

The correspondence distance is short. (Sound skips.)

- ➔ If a device that generates electromagnetic radiation, such as a wireless LAN, other BLUETOOTH device(s), or a microwave oven is nearby, move away from such sources.

Cannot operate the unit. (Connection has hung up.)

- ➔ Reset the unit. Pairing information is not deleted by this operation. Insert a small pin, etc., into the hole at a slight angle, and push until you feel a click.

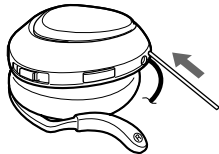

When listening to music

No sound

- ➔ Check that both this unit and the BLUETOOTH device are turned on.
- ➔ Check that both this unit and the BLUETOOTH device are making the BLUETOOTH connection, A2DP (Advanced Audio Distribution Profile).
- ➔ Check that music is being played back by the BLUETOOTH device.
- ➔ Check that the volume of the unit is not set too low.

- ➔ If it is necessary to adjust the volume on the connected device as well, turn up the volume on the connected device.
- ➔ Pair this unit and BLUETOOTH device again.

Low sound level

- ➔ Turn up the volume of this unit.
- ➔ If it is necessary to adjust the volume on the connected device as well, turn up the volume on the connected device.

Low sound quality

- ➔ Switch the BLUETOOTH connection to A2DP (Advanced Audio Distribution Profile) when HSP (Headset Profile) is set.

When calling

The recipient's voice cannot be heard.

- ➔ Check that both this unit and the BLUETOOTH mobile phone are turned on.
- ➔ Check the connection between this unit and the BLUETOOTH mobile phone.
- ➔ Check that output of the BLUETOOTH mobile phone is set for this unit.
- ➔ Check that the volume of the unit is not set too low.
- ➔ Check that the volume of the BLUETOOTH mobile phone is not set too low if the BLUETOOTH mobile phone has a volume control.
- ➔ If you are listening to music using this unit, stop playback, press the multi function button and talk.

Low sound from recipient

- ➔ Turn up the volume of this unit.
- ➔ Turn up the volume of the BLUETOOTH mobile phone if the BLUETOOTH mobile phone has a volume control.

Initializing the unit

You can reset this unit to its default (such as volume setting) and delete all pairing information.

- 1 If this unit is turned on, press and hold the POWER button for about 3 seconds to turn off this unit.**
- 2 Press and hold the POWER button and multi function button together for about 7 seconds.**

The indicator (blue) and indicator (red) flash together four times, and this unit is reset to the default setting. All pairing information is deleted.

Specifications

General

Communication System

BLUETOOTH Specification version 2.0

Output

BLUETOOTH Specification Power Class 2

Maximum communication range

Line of sight approx. 10 m (30 ft) *¹

Frequency band

2.4 GHz band (2.4000 GHz – 2.4835 GHz)

Modulation method

FHSS

Compatible BLUETOOTH Profiles*²

A2DP (Advanced Audio Distribution Profile)

AVRCP (Audio Video Remote Control Profile)

HSP (Headset Profile)

HFP (Hands-free Profile)

Supported Codecs*³

SBC*⁴, MP3

Supplied accessory

AC power adaptor (1)

*¹ The actual range will vary depending on factors such as obstacles between devices, magnetic fields around a microwave oven, static electricity, reception sensitivity, antenna's performance, operating system, software application, etc.

*² BLUETOOTH standard profiles indicate the purpose of BLUETOOTH communication between devices.

*³ Codec: Audio signal compression and conversion format

*⁴ Subband Codec

Headset

Power source

DC 3.7 V: Built-in lithium-ion rechargeable battery

Mass

Approx. 60 g (2.12 oz)

Receiver

Type

Open air, dynamic

Driver unit

30 mm dome type

Reproduction frequency range

20 – 20,000 Hz

Microphone

Type

Omni directional, electret condenser

Effective frequency range

100 – 4,000 Hz

Design and specifications are subject to change without notice.

<http://www.sony.net/>

Printed in Malaysia



* 2 6 9 6 1 1 4 6 1 * (1)