

Wireless Speaker System

Operating Instructions



SRS-BTM30

WARNING

To reduce the risk of fire or electric shock, do not expose this apparatus to rain or moisture.

To reduce the risk of electrical shock, do not open the cabinet. Refer servicing to qualified personnel only.

Do not install the appliance in a confined space, such as a bookcase or built-in cabinet.

To reduce the risk of fire, do not cover the ventilation of the apparatus with newspapers, tablecloths, curtains, etc. And do not place lighted candles on the apparatus.

To reduce the risk of fire or electric shock, do not place objects filled with liquids, such as vases, on the apparatus.

Connect the AC power adaptor to an easily accessible AC outlet. Should you notice an abnormality in the AC power adaptor, disconnect it from the AC outlet immediately.

The Bluetooth word mark and logos are owned by the Bluetooth SIG, Inc. and any use of such marks by Sony Corporation is under license. Other trademarks and trade names are those of their respective owners.

MPEG Layer-3 audio coding technology and patents licensed from Fraunhofer IIS and Thomson.

Table Of Contents

Features	4
Using the BLUETOOTH connection ..	5
Unpacking	6
Location and Function of Parts	7
Power Sources	8
Using on the mains	8
Using with batteries	8
Installing the Speaker	9
Using the BLUETOOTH Connection	10
On pairing	10
On indicators	10
Pairing with a source device	11
Listening to the sound	12
Using by Connecting with a Cord	14
Hooking up the speaker	14
Listening to the sound	15
Precautions	16
What is BLUETOOTH technology?	18
Troubleshooting	19
Common	19
When using the BLUETOOTH connection	19
Initializing This Unit	20
Specifications	21

Features

This unit is a wireless speaker system that uses BLUETOOTH™ wireless technology. You can enjoy listening to the sound wirelessly with your mobile phone, personal computer, portable music player or other BLUETOOTH supported device.*

* BLUETOOTH devices to be connected with this unit are required to support A2DP (Advanced Audio Distribution Profile).

Powerful wireless sound

- Supports BLUETOOTH wireless technology
- Built-in high power (6 W) amplifier
- Super-sensitivity neodymium magnets provide high quality sound

Versatile use in multiple locations

- Two-way power supply: AC adaptor (supplied) or batteries (not supplied).
- Compact, 1-piece design for easy portability.
- Magnetically-shielded design for use in close proximity to your TV set with no adverse effects to its screen.
- Equipped with an analogue input for connection to an audio device not supporting BLUETOOTH wireless technology.

BLUETOOTH connection

This unit can receive stereo audio signal from a BLUETOOTH stereo audio source device (mobile phone, digital music player, etc.) supporting A2DP.

By converting the wireless stereo audio signal (digital) to analogue audio signal, you can enjoy listening to the sound with this unit.

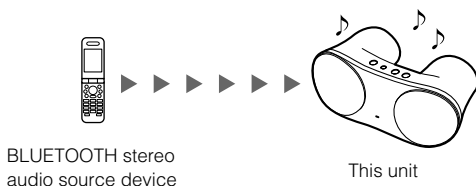

Connection with a cord

You can enjoy listening to the sound from the device connected to the INPUT jack.

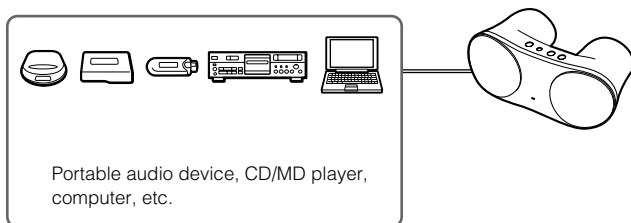

Using the BLUETOOTH connection

In the example below, we explain how to receive the sound played on a BLUETOOTH mobile phone with the sound playback function and listen to the sound on this unit.

Pairing

Enables a BLUETOOTH mobile phone and this unit to recognize one another.

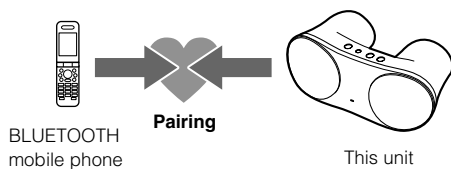

For more details, see pages 10 and 11.



BLUETOOTH connection

Operate the BLUETOOTH mobile phone to make the BLUETOOTH connection.

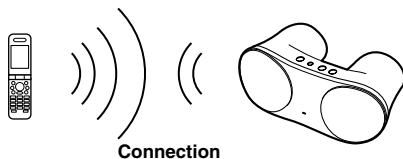

Listening to the sound

Enjoy listening to the sound played on the BLUETOOTH mobile phone through this unit.

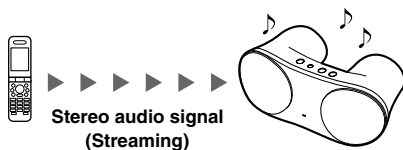

For more details, see page 12.

Unpacking

Check that you have the following items:

- Wireless Speaker System (1)

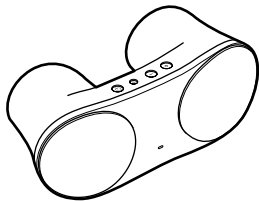

- AC power adaptor (1)
- AC power cord (Mains lead) (1)
- Operating Instructions (1)

Location and Function of Parts

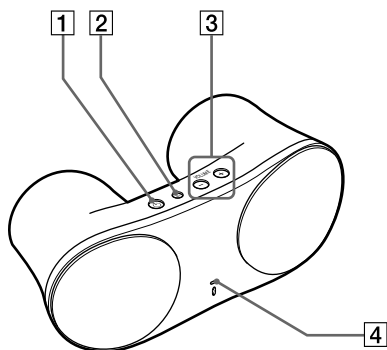

1  **(power) button/indicator**

Press to turn on the unit. Press and hold to turn off the unit.

The  icon in the button lights up, flashes, or goes off. (See page 10.)

2 **ID SET (pairing) button**

For pairing with other BLUETOOTH device.

3 **VOLUME +/- buttons**

Adjust the volume.

A beep sounds when the volume is set to minimum or maximum.

4  **(communication status) indicator**

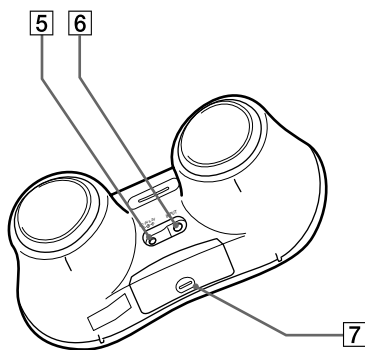

5 **DC IN 5.2 V jack**

Connects the supplied AC power adaptor.

6 **INPUT (audio input) jack**

Connects to the LINE OUT or to headphone jack of a computer, portable audio device, etc.

7 **Battery compartment**

Insert three R6 (size AA) batteries (optional).

Power Sources

Using on the mains

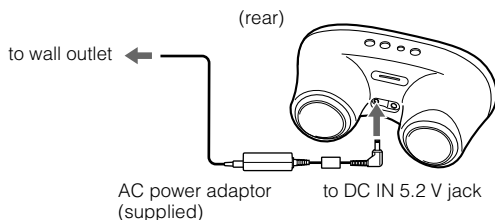

When the AC power adaptor is connected to the system, internal batteries are automatically disconnected.

Note

When connecting or disconnecting the AC power adaptor, turn off the system beforehand. Otherwise, it may cause malfunction.

Note on the AC power adaptor

Use only the supplied AC power adaptor. Do not use any other AC power adaptor to avoid damaging the speaker.



Using with batteries

Battery installation

- 1 Open the battery compartment lid.

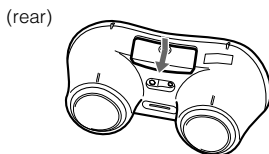

- 2 Insert three R6 (size AA) batteries (optional). Be sure to match the + and – indications on the batteries with the + and – indications on the battery compartment.



Battery replacement

When the batteries are weak, the ⏻ indicator will start flickering and become faint, or the playback sound will become distorted or unstable. In such a case, replace all the batteries with new ones.

Battery life

(5 mW + 5 mW output)

Battery type	Usage time
Sony alkaline battery LR6 (size AA) (SG)	Approx. 15 hours*
Sony manganese battery R6 (size AA)	Approx. 5 hours*

* Usage time stated above may vary according to the temperature or conditions of use.

Installing the Speaker

Install this unit on a level surface, as illustrated below. This unit can be used either laid flat, or in an upright position.

Flat

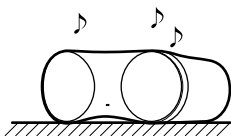

Upright

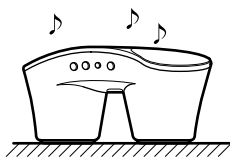

Using the BLUETOOTH Connection

By using the BLUETOOTH connection, you can listen to the sound from a BLUETOOTH stereo audio source device with this unit wirelessly.

Example

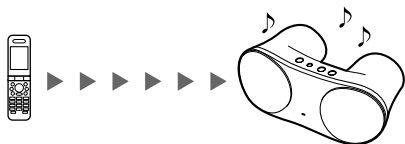

BLUETOOTH mobile phone or
other BLUETOOTH stereo
audio source device

This unit

Note

For details on how to operate the device to be connected, refer to the operating instructions supplied with the device.

On pairing

What is pairing?

BLUETOOTH devices need to be “paired” with each other beforehand. Once BLUETOOTH devices are paired, there is no need for pairing again, except in the following cases:

- Pairing information is deleted after repair, etc.
- This unit is paired with 9 or more devices.
This unit can be paired with up to 8 BLUETOOTH stereo audio source devices. If a new device is paired after 8 devices have been paired, the device whose latest connection time is the oldest among the 8 paired devices is replaced by the new one.
- This unit is reset.
All pairing information is deleted. (See page 20.)

See page 11 on how to pair devices.

On indicators

Status	⏻ indicator (green)	📶 indicator (blue)
Power on	Lights up	Off
Pairing mode	Flashes	Flashes
Connecting or communicating	Lights up	Lights up



Pairing with a source device

Check the following before operating the unit.

- This unit is connected to a power source and the  indicator (green) goes off.

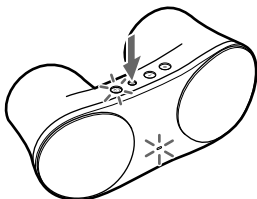
1 Press and hold the ID SET button for 7 seconds or more.



When the  indicator (green) and  indicator (blue) start flashing together, release the button. This unit enters pairing mode.

Note

Pairing mode is cancelled and this unit is turned off after about 5 minutes. If this unit is turned off while performing the procedure, start over from step 1.

2 Perform pairing procedure on the BLUETOOTH stereo audio source device to detect this unit.

The list of detected devices appear on the display of the BLUETOOTH stereo audio source device.

This unit is displayed as “SRS-BTM30.”

If “SRS-BTM30” is not displayed, repeat from step 1.

Notes

- When pairing, be sure to place both the BLUETOOTH devices within 1 m (3 ft) of each other.
- Some devices cannot display the list of detected devices.



3 Select “SRS-BTM30” shown in the display of the BLUETOOTH stereo audio source device.

4 If Passcode* input is required on the display of the BLUETOOTH stereo audio source device, input “0000.”

* Passcode may be called “Passkey,” “PIN code,” “PIN number,” or “Password.”

5 Start the BLUETOOTH connection from the BLUETOOTH device.

Some BLUETOOTH stereo audio source devices may connect with the unit automatically when pairing is complete.

When the BLUETOOTH connection is made properly, both the  indicator (green) and  indicator (blue) light up indicating that pairing is complete, and pairing information is memorized on this unit.

Note

If you turn off this unit or the BLUETOOTH stereo audio source device before the BLUETOOTH connection is complete, pairing information is not memorized and pairing will not be completed.

When pairing with a BLUETOOTH stereo audio source device that cannot display a list of detected devices or that has no display

You may pair the device by setting both this unit and the BLUETOOTH stereo audio source device to pairing mode. For details, refer to the operating instructions supplied with the device.

If pairing is not complete

Start over from step 1.

Tip

To pair with other BLUETOOTH devices, repeat steps 1 to 5 for each device.

Note

Passcode of this unit is fixed to "0000." This unit cannot be paired with a BLUETOOTH stereo audio source device whose Passcode is not "0000."

Listening to the sound

Check the following before operating the unit.

- The BLUETOOTH stereo audio source device's BLUETOOTH function is on.
- Pairing of this unit and the BLUETOOTH stereo audio source device is complete.
- If you have been listening to the sound from the source device connected to the INPUT jack, stop playing on the device or turn off the device.

1 Press the button to turn on this unit.

2 Start the BLUETOOTH connection from the BLUETOOTH stereo audio source device.

3 Start playing on the BLUETOOTH stereo audio source device.

Note

If the source device has a bass boost function or equalizer function, set them to off. If these functions are on, sound may be distorted.

4 Adjust the volume.

Set the volume of the BLUETOOTH stereo audio source device to moderate level, and press the VOLUME +/- buttons on this unit.

Note

A beep sounds when the volume is set to minimum or maximum.

Notes

- In the following cases, you need to make the BLUETOOTH connection again.
 - The power of this unit does not turn on.
 - The power of the BLUETOOTH stereo audio source device does not turn on, or the BLUETOOTH function is off.
 - The BLUETOOTH function of this unit or the BLUETOOTH stereo audio source device is in sleep mode.
 - The BLUETOOTH connection is not made.
- If both the BLUETOOTH connected device and the one connected to the INPUT jack are played at the same time, both sounds can be heard.

To finish listening

Terminate the BLUETOOTH connection by any of the operations below.

- Operate the BLUETOOTH stereo audio source device to terminate the connection. For details, refer to the operating instructions supplied with the device.
- Turn off the BLUETOOTH stereo audio source device.
- Turn off this unit.

Tip

You can adjust the volume of this unit with the BLUETOOTH stereo audio source device supporting AVRCP (Audio/Visual Remote Control Profile) Volume UP/DOWN. For details, refer to the operating instructions supplied with the device.

Note

The volume of this unit may not be controlled as intended depending on the device.

Using by Connecting with a Cord

You can listen to the sound from a device connected to the INPUT jack.

Example

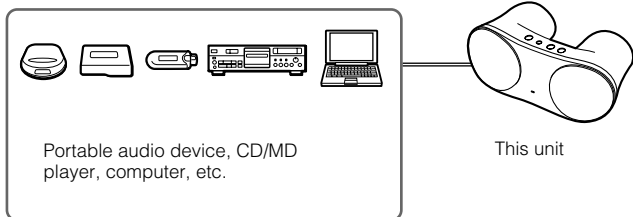

Note

For details on how to operate the device to be connected, refer to the operating instructions supplied with the device.

Hooking up the speaker

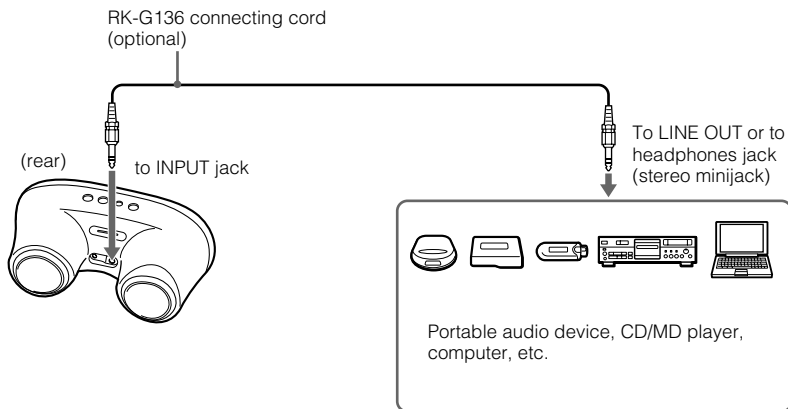

Connect the speaker to the source device.

When the system is connected to the monaural jack of the source device

The sound may not come through the right speaker. In such a case, use the optional* plug adaptor PC-236MS.

To connect to a stereo phone-type headphones jack

Use the optional connecting cord RK-G136 and plug adaptor PC-234S, or optional connecting cords RK-G136 and RK-G138.*

* The above optional accessories are not provided in some areas.

Listening to the sound

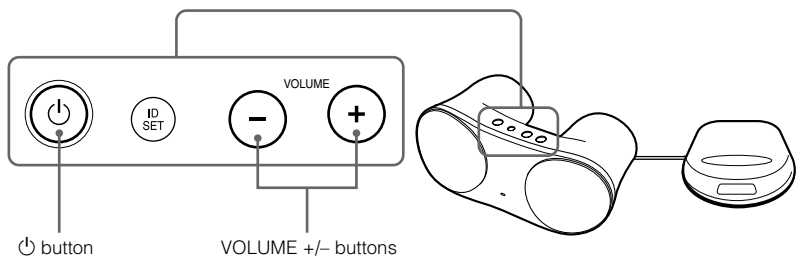

Check the following before operating the unit.

- If you have been listening to the sound from the BLUETOOTH stereo audio source device, stop playing on the device or terminate the BLUETOOTH connection.

1 Press the button to turn on this unit.

The  indicator lights up.

2 Start playing on the source device.

3 Adjust the volume.

Set the volume of the source device to moderate level, and press the VOLUME +/- buttons on this unit.

Note

A beep sounds when the volume is set to minimum or maximum.

4 Press and hold the button to turn off this unit after using.

The  indicator goes off.

Notes

- If connecting the speaker to a device with a built-in radio or tuner, radio broadcasting cannot be received or sensitivity may be reduced significantly.
- If the source device has a bass boost function or equalizer function, set them to off. If these functions are on, sound may be distorted.
- If the source device's headphone output has a line switch, better sound will be heard if it is set to on. See the operating instructions of the source device.
- If both the BLUETOOTH connected device and the one connected to the INPUT jack are played at the same time, both sounds can be heard.

Precautions

On BLUETOOTH communication

- BLUETOOTH wireless technology operates within a range of about 10 meters (about 30 feet). Maximum communication range may vary depending on obstacles (person, metal, wall, etc.) or electromagnetic environment.

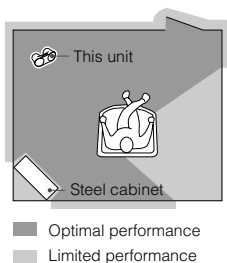

- The following conditions may affect the sensitivity of BLUETOOTH communication.
 - There is an obstacle such as a person, metal, or wall between this unit and BLUETOOTH device.
 - A device using 2.4 GHz frequency, such as a wireless LAN device, cordless telephone, or microwave oven, is in use near this unit.
 - This unit is installed on a shelf made of steel.
- Because BLUETOOTH devices and wireless LAN (IEEE802.11b/g) use the same frequency, microwave interference may occur and resulting in communication speed deterioration, noise, or invalid connection if this unit is used near a wireless LAN device. In such a case, perform the following.
 - Use this unit at least 10 m (about 30 ft) away from the wireless LAN device.
 - If this unit is used within 10 m (about 30 ft) of a wireless LAN device, turn off the wireless LAN device.
 - Install this unit and BLUETOOTH device as near to each other as possible.
- Microwaves emitting from a BLUETOOTH device may affect the operation of electronic medical devices. Turn off this unit and other BLUETOOTH devices in the following locations, as it may cause an accident.
 - where inflammable gas is present, in a hospital, train, airplane, or a petrol station
 - near automatic doors or a fire alarm
- This unit supports security capabilities that comply with the BLUETOOTH standard to provide a secure connection when the BLUETOOTH wireless technology is used, but security may not be enough depending on the setting. Be careful when communicating using BLUETOOTH wireless technology.
- We do not take any responsibility for the leakage of information during BLUETOOTH communication.
- Connection with all BLUETOOTH devices cannot be guaranteed.
 - A device featuring BLUETOOTH function is required to conform to the BLUETOOTH standard specified by BLUETOOTH SIG, and be authenticated.
 - Even if the connected device conforms to the above mentioned BLUETOOTH standard, some devices may not be connected or work correctly, depending on the features or specifications of the device.
- Depending on the device to be connected, it may require some time to start communication.

Notes when using with a mobile phone

- You cannot use this unit to talk over the telephone, even if the BLUETOOTH connection between this unit and a mobile phone is made.
- For details on operation of your mobile phone when receiving a telephone call while transmitting the sound using the BLUETOOTH connection, refer to the operating instructions supplied with the mobile phone.

On safety

The nameplate indicating operating voltage, power consumption, etc., is located on the rear exterior.

- Before operating the system, be sure that the operating voltage of the system is identical with that of your local power supply.

Where purchased	Operating voltage
All countries/regions	100 – 240 V AC, 50/60 Hz

- Use only the supplied AC power adaptor.
- After operating the system with the AC power adaptor, disconnect the AC power adaptor from the wall outlet if the system is not to be used for an extended period of time. Just switching the  button to off does not turn the AC power adaptor off.

On placement

- Do not set the speaker in an inclined position.
- Do not leave the system in a location near heat sources, or in a place subject to direct sunlight, excessive dust, moisture, rain or mechanical shock.

On operation

- Do not open the cabinet. Refer servicing to qualified personnel only.
- Should any solid object or liquid fall into the system, have the system checked by qualified personnel before operating it any further.
- Although this system is magnetically shielded, do not leave recorded tapes, watches, personal credit cards, or floppy disks with magnetic coding in front of the system for an extended period of time.

On cleaning

Do not use alcohol, benzine, or thinner to clean the cabinet.

If the TV picture or monitor display is magnetically distorted

Although this system is magnetically shielded, there may be cases that the picture on some TV sets/personal computer sets may become magnetically distorted. In such a case, turn off the power of the TV set/personal computer set once, and after 15 to 30 minutes turn it on again. For the personal computer set, take the appropriate measures such as data storage before turning it off.

When there seems to be no improvement, locate the system further away from the TV set/personal computer set. Furthermore, be sure not to place objects in which magnets are attached or used near the TV set/personal computer set, such as audio racks, TV stands, toys etc. These may cause magnetic distortion to the picture due to their interaction with the system.

Others

- If you have any questions or problems concerning this unit that are not covered in this manual, please consult your nearest Sony dealer.
- Should any problem persist, consult your nearest Sony dealer.

What is BLUETOOTH technology?

BLUETOOTH wireless technology is a short-range wireless technology that enables wireless data communication between digital devices, such as a computer or digital camera. BLUETOOTH wireless technology operates within a range of about 10 meters (about 30 feet). Connecting two devices as necessary is common, but some devices can be connected to multiple devices at the same time.*

You do not need to use a cable for connection since BLUETOOTH technology is a wireless technology, nor is it necessary for the devices to face one another, such is the case with infrared technology. For example, you can use such a device in a bag or pocket. BLUETOOTH technology is an international standard supported by thousands of companies all over the world, and employed by various companies worldwide.

* This unit cannot be connected to multiple devices at the same time.

Communication System and Compatible BLUETOOTH Profiles of this unit

Profile is standardization of the function for each BLUETOOTH device specification. This unit supports the following BLUETOOTH version and profiles:

Communication System: BLUETOOTH Specification version 2.0

Compatible BLUETOOTH Profiles:

- A2DP (Advanced Audio Distribution Profile)
- AVRCP (Audio/Visual Remote Control Profile) Volume UP/DOWN

Troubleshooting

If you run into any problems using this unit, use the following checklist. Should any problem persist, consult your nearest Sony dealer.

Common

No sound

- ➔ Check that both this unit and the source device are turned on.
- ➔ Turn up the volume of the unit.
- ➔ Replace all the batteries with new ones, if they are used with this system.
- ➔ Turn up the volume of the source device as high as possible to the extent that sound is not distorted. For details on volume adjustment, refer to the operating instructions supplied with the device.
- ➔ Make sure all the connections have been correctly made.

Low sound level

- ➔ Turn up the volume of the source device as high as possible to the extent that sound is not distorted. For details on volume adjustment, refer to the operating instructions supplied with the device.
- ➔ Turn up the volume of the unit.
- ➔ Replace all the batteries with new ones, if they are used with this system.

Distorted sound

- ➔ Turn down the volume of the source device to the point where the sound is no longer distorted. For details on volume adjustment, refer to the operating instructions supplied with the device.
- ➔ If the source device has a bass boosts function, set it to off.
- ➔ Turn down the volume of the unit.
- ➔ Replace all the batteries with new ones, if they are used with this system.

There is hum or noise in the speaker output.

- ➔ Make sure all the connections have been correctly made.
- ➔ Make sure none of the audio devices are positioned too close to the TV set.

The brightness of the indicator is unstable.

- ➔ The brightness of the  indicator may become unstable when the volume is turned up. This is not malfunction.

When using the BLUETOOTH connection

No sound

- ➔ Ensure that this unit is not too far from the BLUETOOTH stereo audio source device, or this unit is not receiving interference from a wireless LAN, other 2.4 GHz wireless device, or microwave oven.
- ➔ Check that the BLUETOOTH connection is made properly between this unit and the BLUETOOTH stereo audio source device.
- ➔ Pair this unit and the BLUETOOTH stereo audio source device again.

Sound skips or the correspondence distance is short.

- ➔ If a device that generates electromagnetic radiation, such as a wireless LAN, other BLUETOOTH device(s), or a microwave oven is nearby, move away from such sources.
- ➔ Remove any obstacle between this unit and other BLUETOOTH device or move away from the obstacle.
- ➔ Locate this unit and other BLUETOOTH device(s) as near as possible.
- ➔ Re-position this unit.
- ➔ Re-position other BLUETOOTH device.

Pairing cannot be done.



- ➔ Bring this unit and the BLUETOOTH device closer together.



Sound is delayed.

- ➔ If you watch a TV or a DVD through BLUETOOTH connection via this unit, sound may lag behind the picture.

Initializing This Unit

You can reset this unit to its default and delete all pairing information.

- 1 If this unit is turned on, press and hold the  button to turn off this unit.**
- 2 While holding the  button, press the ID SET button for 7 seconds or more.**

The  indicator (green) and the  indicator (blue) flash four times, and this unit is reset to the default setting. All pairing information is deleted.

Specifications

Speaker section

Speaker system

48 mm, Full range, magnetically shielded

Enclosure type

Bass reflex

Impedance

4 Ω

Rated input power

3 W

Maximum input power

6 W

Amplifier section

Rated output

3 W + 3 W (10% T.H.D., 1 kHz, 4 Ω)

Bass Boost

MEGA BASS

Audio input

Stereo minijack \times 1

Input impedance

4.7 k Ω (at 1 kHz)

General

Power

Three R6 (size AA) batteries, DC 5.2V
(supplied AC power adaptor)

Dimensions (w/h/d)

Approx. 280 \times 111 \times 140 mm
(11 $\frac{1}{8}$ \times 4 $\frac{3}{8}$ \times 5 $\frac{5}{8}$ in.)

Mass

Approx. 750 g (1 lb. 10 oz.) including batteries

Communication System

BLUETOOTH Specification version 2.0

Output

BLUETOOTH Specification Power Class 2

Maximum communication range

Line of sight approx. 10 m (30 ft)*¹

Frequency band

2.4 GHz band (2.4000 GHz–2.4835 GHz)

Modulation method

FHSS

Compatible BLUETOOTH Profiles*²

A2DP (Advanced Audio Distribution Profile)

AVRCP (Audio/Visual Remote Control Profile)

Volume UP/DOWN

Supported Codecs*³

SBC*⁴, MP3

*¹ The actual range will vary depending on factors such as obstacles between devices, magnetic fields around a microwave oven, static electricity, reception sensitivity, antenna's performance, operating system, software application, etc.

*² BLUETOOTH standard profiles indicate the purpose of BLUETOOTH communication between devices.

*³ Codec: Audio signal compression and conversion format

*⁴ Subband Codec

Supplied accessories

AC power cord (Mains lead) (1)

AC power adaptor (1)

Operating Instructions (1)

Optional accessories

Connecting cord RK-G136, RK-G138

Plug adaptor PC-234S, PC-236MS

The above optional accessories are not provided in some areas.

Design and specifications are subject to change without notice.

<http://www.sony.net/>



Printed on 70% or more recycled paper
using VOC (Volatile Organic
Compound)-free vegetable oil based ink.

Printed in Malaysia



* 2 6 9 5 0 6 5 5 1 * (1)