

# Radio Cassette Player

## Operating Instructions/使用說明書



### WM-FX700

©2003 Sony Corporation Printed in China

http://www.sony.net/

"WALKMAN" is a registered trademark of Sony Corporation to represent Headphone Stereo products.

WALKMAN is a trademark of Sony Corporation.

The validity of the CE marking is restricted to only those countries where it is legally enforced, mainly in the countries EEA (European Economic Area).

CE 標誌的有效性，僅限於那些有法律限制的國家，主要在 EEA (歐洲經濟區) 國家。

## WARNING

To prevent fire or shock hazard, do not expose the unit to rain or moisture.

Do not install the appliance in a confined space, such as a bookcase or built-in cabinet.

## 警告

為防火災或觸電危險，切勿讓機器暴露於雨中或潮濕處。

別把機器安裝在例如書櫥或壁櫃等密不通風的地方。

## A

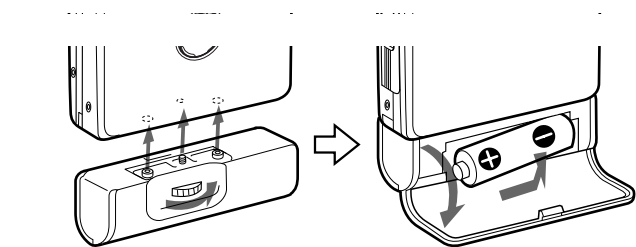

## B

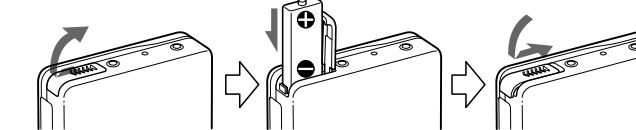
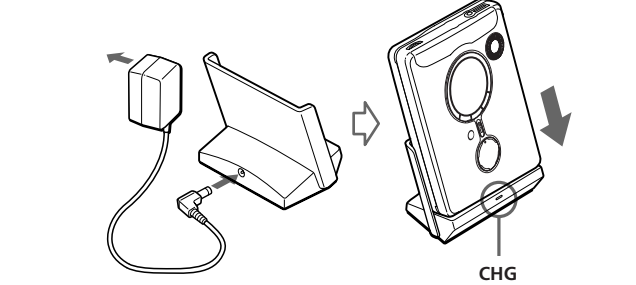

## C

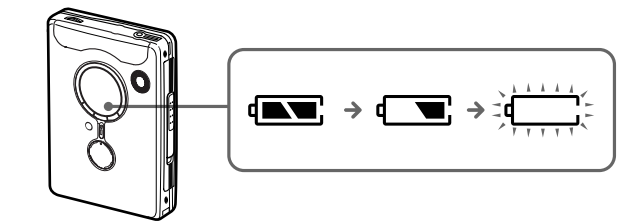

## D

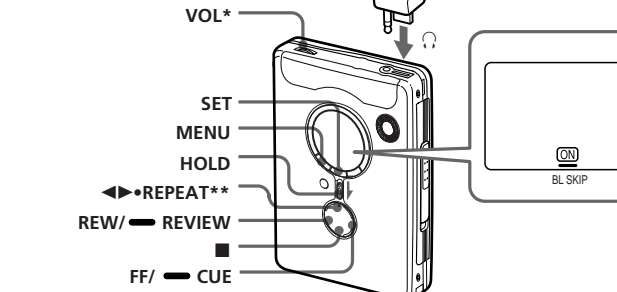
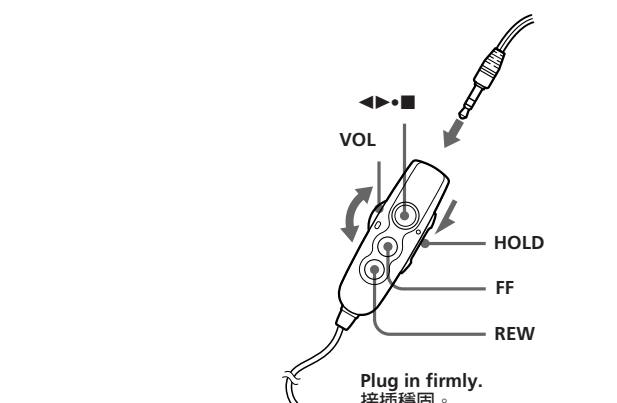
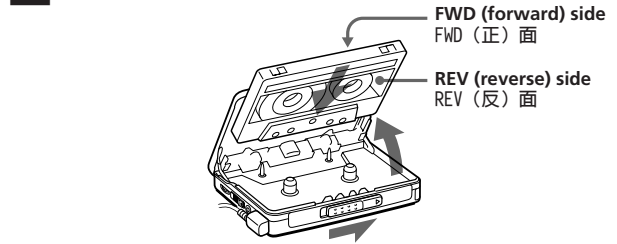

\* There is a tactile dot beside VOL on the main unit to show the direction to turn up the volume.

\*\* The button has a tactile dot.

\* 在主機上 VOL 旁邊有一個觸感圓點，表示轉大音量的方向。

\*\* 按鈕帶有突起圓點。

## English

- To prevent fire, do not cover the ventilation of the apparatus with newspapers, table-cloths, curtains, etc. And don't place lighted candles on the apparatus.
- To prevent fire or shock hazard, do not place objects filled with liquids, such as vases, on the apparatus.
- Certain countries may regulate disposal of the battery used to power this product. Please consult with your local authority.

## Preparations

Prepare a dry battery (not supplied) or the rechargeable battery (supplied).

### Dry Battery [A]

Attach the supplied battery case, and then insert one R6 (size AA) battery with correct polarity.

Note  
For maximum performance we recommend that you use a Sony alkaline battery.

### Rechargeable Battery [B]

Charge the rechargeable battery before using it for the first time.

- Insert the supplied rechargeable battery NH-10WM into the rechargeable battery compartment with correct polarity.
- Connect the supplied AC power adaptor to the charging stand, plug in the AC power adaptor to the house current (mains). If the plug does not fit to your mains, attach the supplied AC plug adaptor (Saudi Arabian model only).
- Place the main unit on the charging stand. The CHG lamp will light up during charging. Full charging takes about 6 hours regardless of the battery power remaining. The CHG lamp will go off when the battery is fully charged.

### Notes

- This charging stand charges the rechargeable battery based on a timer. If you remove the unit from the charging stand while it is charging, the timer will be reset and full charging will take about 6 hours when you place the unit on the charging stand again.
- You can use the unit before the CHG lamp goes off, but in that case, battery life will be shorter depending on the charging time.

- Do not use the unit while it is charging. Remove the unit from the charging stand when using it.
  - If you operate the unit while it is charging, the battery will not be charged.
  - If you operate the unit while it is charging, this may cause a malfunction.
- Do not place the unit on the charging stand without the rechargeable battery. Otherwise, this may cause a malfunction.

### When to replace/charge the battery [C]

Replace or charge the battery when " " flashes in the display.

### Battery life\* (Approx. hours)

Sony alkaline LR6 (SG)**	
Tape playback	50
Radio reception	56

### Rechargeable battery NH-10WM

Tape playback	22
Radio reception	25

### Sony alkaline LR6 (SG)\*\* and Rechargeable NH-10WM

Tape playback	72
Radio reception	81

\* Measured value by the standard of JEITA (Japan Electronics and Information Technology Industries Association). (Using a Sony HF series cassette tape)

\*\* When using a Sony LR6 (SG) alkaline dry battery (produced in Japan).

Notes  
• The battery life may be shorter depending on the operating condition, the surrounding temperature and battery type.  
• The AVLS setting (see "Using the Menu") will be cancelled when you replace the battery.

## Playing a Tape [D]

- Insert a cassette and if the HOLD function is on, slide the HOLD switch in the opposite direction of the arrow to unlock the controls.
- Press ◀▶•REPEAT on the main unit and adjust the volume with VOL. (On the remote control, press ▶▶(play)•■(stop).)

### When adjusting the volume on the remote control

Set the VOL control on the main unit to around 6.

### When adjusting the volume on the main unit

Set the VOL control on the remote control at maximum.

### Operation on the remote control

To	Press
Switch playback to the other side	◀▶•■ for 2 seconds or more during playback
Stop playback	▶▶•■ once during playback
Repeat the current track (Repeat Single Track function)	◀▶•■ twice during playback <i>To stop a single repeat, press ▶▶•■ once.</i>
Fast forward*	FF during stop
Rewind*	REW during stop
Search forward during playback (CUE)	Press and hold FF and release it at the point you want
Search backward during playback (REVIEW)	Press and hold REW and release it at the point you want
Play the next track/succeeding 9 tracks from the beginning (AMS**)	FF once/repeatedly during playback
Play the current track/previous 8 tracks from the beginning (AMS**)	REW once/repeatedly during playback
Play the other side from the beginning (Skip Reserve function)	FF for 2 seconds or more during stop
Play the same side from the beginning (Rewind Auto Play function)	REW for 2 seconds or more during stop

### Operation on the main unit

To	Press
Switch playback to the other side	◀▶•REPEAT during playback
Stop playback	■ (stop)
Repeat the current track (Repeat Single Track function)	◀▶•REPEAT for 2 seconds or more during playback <i>To stop a single repeat, press ▶▶•REPEAT once.</i>
Fast forward*	FF/CUE during stop
Rewind*	REW/REVIEW during stop

Search forward during playback (CUE) Press and hold FF/CUE and release it at the point you want

Search backward during playback (REVIEW) Press and hold REW/REVIEW and release it at the point you want

Play the next track/succeeding 9 tracks from the beginning (AMS\*\*) FF/CUE once or repeatedly during playback

Play the current track/previous 8 tracks from the beginning (AMS\*\*) REW/REVIEW once or repeatedly during playback

Play the other side from the beginning (Skip Reverse function) FF/CUE for 2 seconds or more during stop

Play the same side from the beginning (Rewind Auto Play function) REW/REVIEW for 2 seconds or more during stop

\* Press ◀▶•REPEAT (on the remote control, press ▶▶•■) during fast forward or rewind to start playback.

\*\*Automatic Music Sensor

### To skip a long blank space (BL SKIP\* function)

- Press MENU repeatedly to set " " (the cursor) in the display to BL SKIP.
- Press SET to show " ".

\* When the BL SKIP function is on, the tape is fast-forwarded to the next track if there is a blank space longer than 12 seconds.

(turn over)

## 中文

- 為防止火災，請勿讓報紙、桌布、窗簾等蓋住裝置的通風孔。也不可把點燃的蠟燭放在裝置上。
- 為防止火災或觸電的危險，請勿將裝滿液體的物體，例如花瓶等放在裝置上。
- 一部份國家對本產品的電源用電池的處置，可能有所規定。此請詢問當地有關當局。

## 準備工作

準備乾電池（無附帶）或充電式電池（附帶）。

### 乾電池 [A]

安裝附帶的電池盒，然後按正確極性裝入一節 R6 (AA) 電池。

註  
為獲得最佳效果，建議您使用 Sony 牌鹼性電池。

### 充電式電池 [B]

充電式電池在第一次使用前，必須加以充電。

- 以正確極性將附帶的充電式電池 NH-10WM 裝入充電式電池盒。
- 將附帶的 AC 電源轉接器連接到充電座，將 AC 電源轉接器插到家庭用電源插座（主電源）。如果插頭與所用主電源插座不匹配，請裝上附帶的 AC 電源插頭轉接器（僅限於沙特阿拉伯型號）。
- 將主機放在充電座上。CHG 燈將在充電時點亮。無論原有電力多少，完全充電需時大約 6 小時。當電池完全充滿電時，CHG 燈將熄滅。

註  
• 充電座以計時方式為充電式電池進行充電。如果您在充電時將機器由充電座上卸下，計時器可能會重新計時；當您將機器重新放回充電座後，將需要約 6 小時才能完全充電。

• 在 CHG 燈熄滅前，您可以使用機器，但是在此情況下，電池壽命將會變短，視充電時間而定。

• 充電中，請別使用機器。要使用機器時，須把機器從充電座上卸下。

– 充電中，您如果操作機器，電池便不能進行充電了。

– 充電中，您如果操作機器，便可能引起故障。

• 別把沒有安裝充電式電池的機器裝放在充電座上。否則便可能引起故障。

### 何時更換電池/給電池充電 [C]

" " 在顯示窗中閃爍時，即請更換電池或給電池充電。

### 電池壽命\* (大約時數)

Sony 鹼電池 LR6 (SG)**	
錄音帶收音	50
聽收音機	56

### 充電式電池 NH-10WM

錄音帶收音	22
聽收音機	25

### 同時使用 Sony 鹼電池 LR6 (SG)\*\* 和充電式電池 NH-10WM

錄音帶收音	72
聽收音機	81

\* 按 JEITA (Japan Electronics and Information Technology Industries Association) 標準測定的值。（使用 Sony HF 系列磁帶）

\*\* 使用 LR6 (SG) 型 Sony 鹼電池（日本製）時。

註  
• 電池壽命可能因操作條件、環境溫度和電池類型而縮短些。

• 當更換電池時，AVLS 設定（參見“使用項目單”）將被取消。

## 播放錄音帶 [D]

- 裝入卡帶，如果遙控器的 HOLD 功能仍打開著，即請沿相反於箭頭方向滑動 HOLD 開關以釋放控制鈕。
- 按主機上的 ◀▶•REPEAT 並用 VOL 調節音量。（在遙控器上，則請按 ▶▶(放音)•■(停止)。）

在遙控器上調節音量時  
請把主機上的 VOL 控制鈕設定於 6 左右。

在主機上調節音量時  
請把遙控器上的 VOL 控制鈕設定於最大。

### 在遙控器上的操作

要	請按
換播放另一面	播放中按 ◀▶•■ 2 秒以上
停止播放	播放中按一次 ◀▶•■

從頭播放當前曲子（重複單一曲子功能）在播放中按兩次 ◀▶•■ 要停止重複單一曲子，請按 ▶▶•■ 一次。

快進繞\* 停止中按 FF

重繞\* 停止中按 REW

在播放中向前後搜尋 (CUE) 按住 FF 然後在想要的位置鬆開

在播放中向後搜尋 (REVIEW) 按住 REW 然後在想要的位置鬆開

從頭播放下一曲子/接下9首曲子 (AMS\*\*) 播放中按一次或重複按 FF

從頭播放當前曲子/前面8首曲子 (AMS\*\*) 播放中按一次或重複按 REW

從頭播放另一面 (跳躍倒繞功能) 停止中按 FF 並保持 2 秒以上或更久

從頭播放同一面 (重繞自動播放功能) 停止中按 REW 並保持 2 秒以上或更久

### 在主機上的操作

要	請按
換播放另一面	播放中按 ◀▶•REPEAT
停止播放	按 ■ (停止)
從頭播放當前曲子（重複單一曲子功能）	在播放中按 ◀▶•REPEAT 保持 2 秒以後或更久 要停止重複單一曲子，請按 ▶▶•REPEAT 一次。
快進繞*	停止中按 FF/CUE
重繞*	停止中按 REW/REVIEW

在播放中向前後搜尋 (CUE) 按住 FF/CUE 然後在想要的位置鬆開

在播放中向後搜尋 (REVIEW) 然後在想要的位置鬆開

從頭播放下一曲子/接下9首曲子 (AMS\*\*) 播放中按一次或重複按 FF/CUE

從頭播放當前曲子/前面8首曲子 (AMS\*\*) 播放中按一次或重複按 REW/REVIEW

從頭播放另一面 (跳躍倒繞功能) 停止中按 FF/CUE 並保持 2 秒以上或更久

從頭播放同一面 (重繞自動播放功能) 停止中按 REW/REVIEW 並保持 2 秒以上或更久

\* 在快進繞或重繞時按 ◀▶•REPEAT (在遙控器上，按 ▶▶•■) 以開始播放。

\*\*自動樂曲探測

### 跳過長時間的空白 (BL SKIP\* 功能)

- 重複按下 MENU 將顯示窗中的 " " (游標) 設定為 BL SKIP。
- 按下 SET 顯示 " "。

\* 當 BL SKIP 功能開啓時，如果有超過 12 秒的空白，錄音帶會快速轉到下一首曲子。

(接反面)



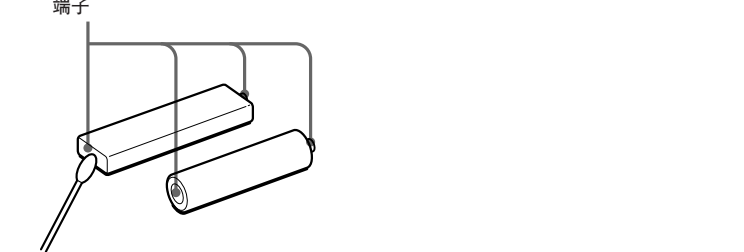
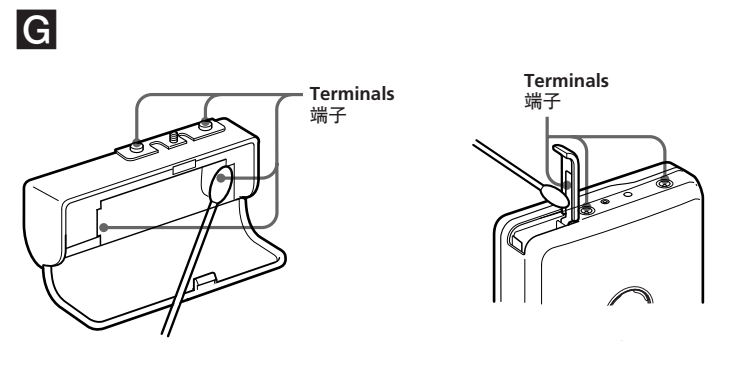
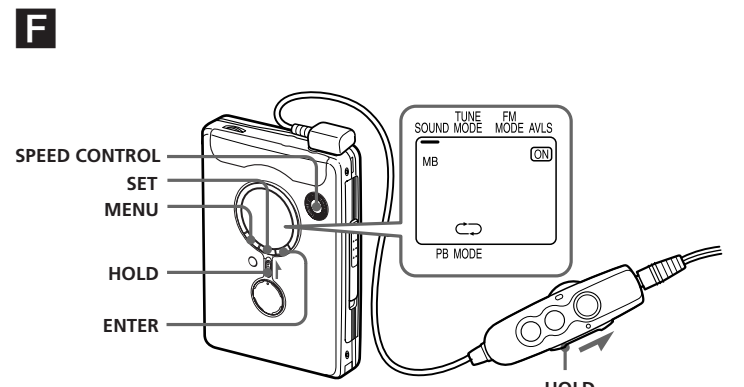
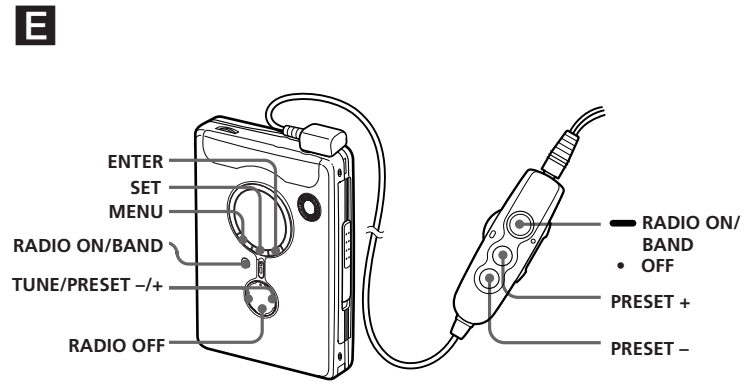

English

## Listening to the Radio

- Press RADIO ON/BAND to turn on the radio.
- Press RADIO ON/BAND repeatedly to select AM or FM.
- Press MENU on the main unit repeatedly and set the cursor in the display to TUNE MODE.
- For manual tuning
  - Press SET to choose MANUAL.
  - Press TUNE/PRESET + or - repeatedly to tune in to the desired station. Hold down TUNE/PRESET + or - for a few seconds to scan for stations.

**For preset tuning**

- Press SET to choose PRESET.
- Press TUNE/PRESET + or - repeatedly to recall the desired preset station.

To use preset tuning, preset stations first see "Presetting Radio Stations").

### To turn off the radio

Press RADIO OFF.

### To improve the broadcast reception

- For AM:** Reorient the unit itself.
- For FM:** Extend the remote control cord (antenna). If the reception is still not good, press MENU repeatedly to set the cursor in the display to FM MODE. Then press SET to choose from "MONO" (monaural), "LOCAL" or none (stereo) for best reception.

### To operate from the remote control

To turn on the radio, press RADIO ON/BAND•OFF for more than 1 second (while the tape is in stop mode only). To select the band, press RADIO ON/BAND•OFF for more than 1 second while the radio is on. To tune in or recall a preset station, press PRESET + or -. To turn off the radio, press RADIO ON/BAND•OFF.

### Presetting Stations Manually

- Press RADIO ON/BAND to turn on the radio.
  - Press RADIO ON/BAND repeatedly to select AM or FM.
  - Press ENTER.
  - While the frequency digits are flashing, tune in to a station you wish to store using TUNE/PRESET + or - and press ENTER.
- The preset number will flash in the display.

## Presetting Radio Stations

You can preset up to 30 stations—20 for FM and 10 for AM (for the JPN area\*, up to 16 stations—8 for FM and 8 for AM).

\* Only if available. See "Receiving Stations Outside Your Country/Region".

### Presetting Automatically Scanned Stations

- Press RADIO ON/BAND to turn on the radio.
- Press RADIO ON/BAND repeatedly to select AM or FM.
- Press and hold ENTER for more than 3 seconds. Preset number 1 will flash in the display and the main unit starts scanning the stations from the lower frequencies and stops for about 5 seconds when a station is received.
- If you wish to preset the currently received station, press ENTER while the preset number is flashing.

The received station is preset on preset number 1 and the unit starts scanning for the next receivable station.

- Repeat step 4 until all receivable stations are preset.

### To stop scanning

Press RADIO OFF. The radio is turned off at the same time.

### Notes

- If stations are already stored, the newly preset stations replace the old ones when the above procedure is completed.
- If stations cannot be preset automatically, preset them manually.

### Presetting Stations Manually

- Press RADIO ON/BAND to turn on the radio.
  - Press RADIO ON/BAND repeatedly to select AM or FM.
  - Press ENTER.
  - While the frequency digits are flashing, tune in to a station you wish to store using TUNE/PRESET + or - and press ENTER.
- The preset number will flash in the display.

The frequency digits will flash in the display.

- While the frequency digits are flashing, tune in to a station you wish to store using TUNE/PRESET + or - and press ENTER.

The preset number will flash in the display.

## 5 While the preset number is flashing, select the preset number you want using TUNE/PRESET + or - and press ENTER.

- Press RADIO ON/BAND to turn on the radio.
- Press RADIO ON/BAND repeatedly to select AM or FM.
- Press MENU on the main unit repeatedly and set the cursor in the display to TUNE MODE.
- For manual tuning
  - Press SET to choose MANUAL.
  - Press TUNE/PRESET + or - repeatedly to tune in to the desired station. Hold down TUNE/PRESET + or - for a few seconds to scan for stations.

### For preset tuning

To use preset tuning, preset stations first see "Presetting Radio Stations").

- Press SET to choose PRESET.
- Press TUNE/PRESET + or - repeatedly to recall the desired preset station.

To use preset tuning, preset stations first see "Presetting Radio Stations").

The received station is preset on preset number 1 and the unit starts scanning for the next receivable station.

- Repeat step 4 until all receivable stations are preset.

### To stop scanning

Press RADIO OFF. The radio is turned off at the same time.

### Notes

- If stations are already stored, the newly preset stations replace the old ones when the above procedure is completed.
- If stations cannot be preset automatically, preset them manually.

### Presetting Stations Manually

- Press RADIO ON/BAND to turn on the radio.
  - Press RADIO ON/BAND repeatedly to select AM or FM.
  - Press ENTER.
  - While the frequency digits are flashing, tune in to a station you wish to store using TUNE/PRESET + or - and press ENTER.
- The preset number will flash in the display.

The frequency digits will flash in the display.

- While the frequency digits are flashing, tune in to a station you wish to store using TUNE/PRESET + or - and press ENTER.

The preset number will flash in the display.

## Receiving Stations Outside Your Country/Region (Excluding European, Saudi Arabian, and Chinese models)

- Press RADIO ON/BAND to turn on the radio.
- Press ENTER.
- Press and hold RADIO ON/BAND until "Eur", "USA" or "JPN" flashes.
- Press RADIO ON/BAND repeatedly to select "Eur", "USA" or "JPN" and press ENTER.
- Turn in to and store stations as necessary following the procedure of "Listening to the Radio" and "Presetting Radio Stations".

### Area indication and frequency range

Area*	Frequency range FM (MHz)	AM(kHz)
Eur	87.5 - 108	531 - 1 602
USA	87.5 - 108	530 - 1 710
JPN	76.0 - 90.0	531 - 1 710

\* Eur :European and other countries/regions  
USA :USA, Canada, and Central and South America  
JPN: Japan

### Locking the Controls — HOLD Function

Slide the HOLD switch in the direction of the arrow to lock the controls of the main unit (except SPEED CONTROL) or the remote control.

### Using the Menu

#### Adjusting Playback Modes

Press MENU repeatedly to set the cursor in the display to PB MODE. Then press SET to select the desired mode.

To play	Select
both sides repeatedly	↔
both sides once	↶ ↷
from the FWD side	→

#### Emphasizing Sound

- Press MENU repeatedly to set the cursor in the display to SOUND.
- Press SET repeatedly to select the sound emphasis of your choice.

The indications change as follows:

- RV : Sound Revitalizer Emphasizes treble sound.
- MB : Mega Bass Emphasizes bass sound (moderate effect).
- GRV : Groove Emphasizes bass sound (strong effect).
- no message : normal (no effect)

## On batteries

- Do not charge a dry battery.
- Do not carry the dry or rechargeable batteries with coins or other metallic objects. It can generate heat if the positive and negative terminals of the batteries are accidentally contacted by a metallic object.
- When you are not going to use the main unit for a long time, remove the battery to prevent any damage from battery leakage and corrosion.

### On AC power adaptor

- Use only the supplied AC power adaptor (for charging stand). Do not use any other AC power adaptor.

### To cancel the AVLS function

Press SET so that "AVLS" disappears from the display on the main unit.

### Using Other Functions

#### Adjusting the Tape Playback Speed

You can adjust the playback speed using SPEED CONTROL. Turn SPEED CONTROL to: - (slow) to play back at a slower speed. Center position to play back at normal speed. + (fast) to play back at a faster speed.

#### Locking the Controls — HOLD Function

Slide the HOLD switch in the direction of the arrow to lock the controls of the main unit (except SPEED CONTROL) or the remote control.

### On charging

- The supplied charging stand can be used only with this unit. No other model can be charged using this stand.
- Remove the AC power adaptor from the wall outlet as soon as possible after the rechargeable battery has been charged. Overcharging may damage the rechargeable battery.
- The charging stand and the rechargeable battery may become warm during charging, but this is not a problem.
- Do not tear off the film on the rechargeable battery.
- Use only the supplied charging stand to charge the supplied rechargeable battery.
- Be sure not to short-circuit the battery. When you carry it with you, use the supplied carrying case. If you are not using the case, do not carry the battery with other metallic objects such as keys, rings in your pocket.
- If the rechargeable battery is new or has not been used for a long time, it may not be charged completely until you use it several times.

### On maintenance

- Clean the tape head and tape path, using a cotton swab and commercially available cleaning solvent after every 10 hours of use.
- To clean the exterior, use a soft cloth slightly moistened in water. Do not use alcohol, benzine or thinner.
- Clean the headphones/earphones and remote control plugs periodically.
- Clean the battery case terminals (both inside and outside) and the terminals periodically with a cotton swab or soft cloth as illustrated.

## Troubleshooting

The sound drops out or comes with excessive noise.

- Clean the headphones/earphones and remote control plugs.

The unit does not operate at all.

- Charge the battery or replace the dry battery with a new one.
- HOLD is activated. Deactivate HOLD.

### Tape operation is not possible.

Insert a cassette tape.

The volume cannot be turned up.

- If AVLS is on, turn it off.

The display and the operations are not normal.

- Remove the power sources for 15 seconds or more, and then set them again.

### Specifications

Radio section	
Frequency range	FM: 76.0 - 90.0 MHz (Japan) 87.5 - 108 MHz (other countries/regions)
AM:	530 - 1 710 kHz (Japan, Central, and South America) 531 - 1 602 kHz (other countries/regions)

### Tape section

Frequency response Playback: 40 - 15 000 Hz

Output Headphones (⊕) jack Load impedance: 8 - 300 Ω

General Power requirements 1.5 V Rechargeable battery One R6 (size AA) battery

Dimensions (w/h/d) Approx. 77.1 × 108.0 × 22.5 mm (3¼ × 4¼ × ¾ inches) excl. projecting parts and controls

Mass Approx. 153 g (5.4 oz) (main unit only)

Supplied accessories AC power adaptor (1), Battery case (1) Stereo headphones or earphones with remote control (1), Charging stand (1) Rechargeable battery (NH-10WM, 1.2 V, 900 mAh (min), Ni-MH) (1) Rechargeable battery carrying case (1) Carrying pouch (1) AC plug adaptor (1) (Saudi Arabian model only)

### Design and specifications are subject to change without notice.

### On the remote control

Use the supplied remote control only with this unit.

### On headphones/earphones

Road safety Do not use headphones/earphones while driving, cycling, or operating any motorized vehicle. It may create a traffic hazard and is illegal in some areas. It can also be potentially dangerous to play your headphones/earphones at high volume while walking, especially at pedestrian crossings. You should exercise extreme caution or discontinue use in potentially hazardous situations.

### Preventing hearing damage

Do not use headphones/earphones at high volume. Hearing experts advise against continuous, loud and extended play. If you experience a ringing in your ears, reduce volume or discontinue use.

### Caring for others

Keep the volume to a moderate level. This will allow you to hear outside the people around you.

### On maintenance

- Clean the tape head and tape path, using a cotton swab and commercially available cleaning solvent after every 10 hours of use.
- To clean the exterior, use a soft cloth slightly moistened in water. Do not use alcohol, benzine or thinner.
- Clean the headphones/earphones and remote control plugs periodically.
- Clean the battery case terminals (both inside and outside) and the terminals periodically with a cotton swab or soft cloth as illustrated.

## 聽收音機

- 按 RADIO ON/BAND 打開收音機。
- 反復按 RADIO ON/BAND 選擇 AM 或 FM。
- 反復按主機上的 MENU，將顯示窗中的游標設為 TUNE MODE。
- 要手動調音時
  - 按 SET 選擇 MANUAL。
  - 反復按 TUNE/PRESET + 或 - 調入所要的電臺。

### 要預設電臺時

① 按 SET 選擇 PRESET。  
② 反復按 TUNE/PRESET + 或 - 要使用預設調音時，請先預設電臺（參見“預設電臺”）。

### 要關掉收音機時

按 RADIO OFF 鍵。

### 要改善廣播接收效果時

- 收聽 AM 節目時：調轉機器方位。
- 收聽 FM 節目時：請拉長遙控器導線（天線）。如果接收效果仍不好，請反復按 MENU 將主機顯示窗中的游標設為 FM MODE。然後按 SET 從“MONO”（單耳聲）、“LOCAL”或無（立體聲）方式中進行選擇以獲最佳接收效果。

### 要從遙控器進行操作時

要打開收音機時，請按 RADIO ON/BAND•OFF 1 秒以上（限當錄音帶處於停止狀態時）。要選擇波段時，請在打開收音機時，按下 RADIO ON/BAND•OFF 1 秒以上。

### 要關掉收音機時，請按 RADIO ON/BAND•OFF。

要關掉收音機時，請按 RADIO ON/BAND•OFF。

### 顯示窗中即閃爍著頻率數字。

當頻率數字閃爍時，請用 TUNE/PRESET + 或 - 鈕調入您想儲存的電臺，按 ENTER。

### 顯示窗中即將閃爍著預設號。

當預設號閃爍著時，請用 TUNE/PRESET + 或 - 選擇所要預設號並按 ENTER。

### 註

- 如果上述指示閃爍時您不能完成步驟 4 或步驟 5，請從步驟 3 開始重複操作。
- 如果已儲存有電臺，新電臺即將取代原有的電臺。

## 預設電臺

您可以預設多達 30 個電臺—20 個 FM 臺，10 個 AM 臺。（在 JPN 地區\*，最多可以預設 16 個臺—8 個 FM 臺，8 個 AM 臺）。

### 如果可以預設，請參見“接收別的國家/地區的電臺”。

### 自動地預設掃描的電臺

- 按 RADIO ON/BAND 打開收音機。
- 反復按 RADIO ON/BAND 選擇 AM 或 FM。
- 按住 ENTER 3 秒鐘以上。預設號 1 將在顯示屏上閃爍。主機開始從低頻段掃描電臺，在接收到電臺時停止約 5 秒鐘。
- 如果您要預設接收到的電臺，請在預設號閃爍著時按 ENTER。

接收到的電臺即被預設於預設號 1，本機將開始掃描下一個可接收的電臺。

### 要關掉收音機時

按 RADIO OFF 鍵。

### 要改善廣播接收效果時

- 收聽 AM 節目時：調轉機器方位。
- 收聽 FM 節目時：請拉長遙控器導線（天線）。如果接收效果仍不好，請反復按 MENU 將主機顯示窗中的游標設為 FM MODE。然後按 SET 從“MONO”（單耳聲）、“LOCAL”或無（立體聲）方式中進行選擇以獲最佳接收效果。

### 要從遙控器進行操作時

要打開收音機時，請按 RADIO ON/BAND•OFF 1 秒以上（限當錄音帶處於停止狀態時）。要選擇波段時，請在打開收音機時，按下 RADIO ON/BAND•OFF 1 秒以上。

### 要關掉收音機時，請按 RADIO ON/BAND•OFF。

### 顯示窗中即閃爍著頻率數字。

當頻率數字閃爍時，請用 TUNE/PRESET + 或 - 鈕調入您想儲存的電臺，按 ENTER。

### 顯示窗中即將閃爍著預設號。

當預設號閃爍著時，請用 TUNE/PRESET + 或 - 選擇所要預設號並按 ENTER。

### 註

- 如果上述指示閃爍時您不能完成步驟 4 或步驟 5，請從步驟 3 開始重複操作。
- 如果已儲存有電臺，新電臺即將取代原有的電臺。

## 播放預設電臺

- 按 RADIO ON/BAND 打開收音機。
- 反復按 RADIO ON/BAND 選擇 AM 或 FM。
- 反復按 MENU，將顯示器中的游標設定於 TUNE MODE。然後按 SET 以顯示“PRESET”。
- 按 TUNE/PRESET + 或 -。

### 要取消所儲存的電臺時

按照上述方法而在步驟 4 裡選擇所要取消的預設號，然後按 ENTER。顯示窗中即閃爍著頻率數。

按住 TUNE/PRESET + 或 -。頻率數開始增大或減小。按住該按鈕顯示了“----”。

當閃爍著“----”時按 ENTER。顯示窗中即閃爍著預設號。

按 ENTER 以取消儲存的電臺。

### 掃描預設電臺 — DAPS (Digital Auto Preset Scanning)

按 RADIO ON/BAND 打開收音機。

反復按 RADIO ON/BAND 選擇 AM 或 FM。

按住 RADIO ON/BAND 2 秒以上。

所選波段的預設電臺即各播放大約 5 秒。（在 DAPS 當中，顯示窗中將閃爍著指示燈。）

當播放著所要預設電臺時，再按一次 RADIO ON/BAND 以選擇電臺。

### 註

- 如果沒儲存電臺，DAPS 功能將不起作用。
- 步驟 3 裡的 DAPS 功能將繼續打開著一直到在步驟 4 裡已選擇了電臺為止。

### 增強聲音

- 反復按 MENU 把顯示窗中的游標設定於 SOUND。
- 反復按 SET 以選擇所喜歡的聲加強模式。

指示燈改變如下：

RV：Sound Revitalizer（聲音再生器）。增強高音。

MB：Mega Bass（強低音）。增強低音（中等效果）。

GRV：Groove（最佳狀態）。增強低音（強烈效果）。

無信息：普通（無效果）。

註

“GRV”模式時，如果聲音失真了，即請轉小機音量或選其他模式。

## 接收別的國家/地區的電臺

- 按 RADIO ON/BAND 打開收音機。
- 反復按 RADIO ON/BAND 選擇 AM 或 FM。
- 反復按 MENU，將顯示器中的游標設定於 TUNE MODE。然後按 SET 以顯示“PRESET”。
- 按 TUNE/PRESET + 或 -。

### 要取消所儲存的電臺時

按照上述方法而在步驟 4 裡選擇所要取消的預設號，然後按 ENTER。顯示窗中即閃爍著頻率數。

按住 TUNE/PRESET + 或 -。頻率數開始增大或減小。按住該按鈕顯示了“----”。

當閃爍著“----”時按 ENTER。顯示窗中即閃爍著預設號。

按 ENTER 以取消儲存的電臺。

### 地區指示和頻率範圍

地區*	頻率範圍 FM(MHz)	AM(kHz)
Eur	87.5 - 108	531 - 1 602
USA	87.5 - 108	530 - 1 710
JPN	76.0 - 90.0	531 - 1 710

\* Eur：歐洲和其他國家/地區  
USA：美國、加拿大和中南美  
JPN：日本

### 使用項目單

#### 調整收音方式

請反復按 MENU 把顯示器中的游標設定於 PB MODE，然後按 SET 以選擇所要模式。

要	請選擇
反復放雙面	↔
從 FWD 面放一次雙面	→

#### 增強聲音

- 反復按 MENU 把顯示窗中的游標設定於 SOUND。
- 反復按 SET 以選擇所喜歡的聲加強模式。

指示燈改變如下：

RV：Sound Revitalizer（聲音再生器）。增強高音。

MB：Mega Bass（強低音）。增強低音（中等效果）。

GRV：Groove（最佳狀態）。增強低音（強烈效果）。

無信息：普通（無效果）。

註

“GRV”模式時，如果聲音失真了，即請轉小機音量或選其他模式。

## 保護您的聽覺 — AVLS (自動音量限制系統)

- 限制最大音量以保護聽力。
- 在播放、停止或收音模式中，反復按 MENU 把顯示窗中的游標設為 AVLS。然後按 SET 顯示“AVLS”。